



FCC Part15.247 TEST REPORT

FCC ID: 2ADUIESP-12

Product Name:	WIFI Module
Trademark:	AI-THINKER
Model Number:	ESP-12, ESP
Prepared For :	Shenzhen Anxinke technology co., LTD
Address :	5A,B Building,Gushu WanLiHua Industrial,XiXiang Town, BaoAn District,ShenZhen,China
Prepared By :	Shenzhen BCTC Technology Co., Ltd.
Address :	A. Floor 3, 44 Building, Tanglang Industrial Park B, Taoyuan Street, Nanshan District, Shenzhen, China
Test Date:	Dec. 10 - Dec. 14, 2014
Date of Report :	Dec. 14, 2014
Report No.:	BCTC-141211251E



TEST RESULT CERTIFICATION

Applicant's name : Shenzhen Anxinke technology co., LTD
Address : 5A,B Building,Gushu WanLiHua Industrial,XiXiang Town,
 BaoAn District,ShenZhen,China

Manufacture's Name..... : Shenzhen Anxinke technology co., LTD
Address : 5A,B Building,Gushu WanLiHua Industrial,XiXiang Town,
 BaoAn District,ShenZhen,China

Product description

Product name : WIFI Module
Model and/or type reference : ESP-12
Serial Model : ESP

Standards : FCC Part15.247

Test procedure ANSI C63.4-2003

This device described above has been tested by BCTC, and the test results show that the equipment under test (EUT) is in compliance with the FCC requirements. And it is applicable only to the tested sample identified in the report.

This report shall not be reproduced except in full, without the written approval of BCTC, this document may be altered or revised by BCTC, personal only, and shall be noted in the revision of the document.

Test Result.....: **Pass**

Prepared by(Engineer): *Eric Yang*

Reviewer(Quality Manager): *Sophie Lee*

Approved & Authorized Signer(Manager): *Casey Wang*



**Table of Contents**

	Page
1 . SUMMARY OF TEST RESULTS	5
1.1 TEST FACILITY	6
1.2 MEASUREMENT UNCERTAINTY	6
2 . GENERAL INFORMATION	7
2.1 GENERAL DESCRIPTION OF EUT	7
2.2 DESCRIPTION OF TEST MODES	9
2.3 BLOCK DIGRAM SHOWING THE CONFIGURATION OF SYSTEM TESTED	10
2.4 DESCRIPTION OF SUPPORT UNITS(CONDUCTED MODE)	11
2.5 EQUIPMENTS LIST FOR ALL TEST ITEMS	12
3 . EMC EMISSION TEST	13
3.1 CONDUCTED EMISSION MEASUREMENT	13
3.1.1 POWER LINE CONDUCTED EMISSION LIMITS	13
3.1.2 TEST PROCEDURE	14
3.1.3 DEVIATION FROM TEST STANDARD	14
3.1.4 TEST SETUP	14
3.1.5 EUT OPERATING CONDITIONS	14
3.1.6 TEST RESULTS	15
3.2 RADIATED EMISSION MEASUREMENT	17
3.2.1 RADIATED EMISSION LIMITS	17
3.2.2 TEST PROCEDURE	18
3.2.3 DEVIATION FROM TEST STANDARD	18
3.2.4 TEST SETUP	19
3.2.5 EUT OPERATING CONDITIONS	20
3.2.6 TEST RESULTS (BETWEEN 9KHZ – 30 MHZ)	21
3.2.7 TEST RESULTS (BETWEEN 30MHZ – 1GHZ)	22
3.2.8 TEST RESULTS (ABOVE 1000 MHZ)	23
4 . POWER SPECTRAL DENSITY TEST	33
4.1 APPLIED PROCEDURES / LIMIT	33
4.1.1 TEST PROCEDURE	33
4.1.2 DEVIATION FROM STANDARD	33
4.1.3 TEST SETUP	33
4.1.4 EUT OPERATION CONDITIONS	33
4.1.5 TEST RESULTS	34
5 . BANDWIDTH TEST	40
5.1 APPLIED PROCEDURES / LIMIT	40
5.1.1 TEST PROCEDURE	40



Table of Contents

	Page
5.1.2 DEVIATION FROM STANDARD	40
5.1.3 TEST SETUP	40
5.1.4 EUT OPERATION CONDITIONS	40
5.1.5 TEST RESULTS	41
6 . PEAK OUTPUT POWER TEST	47
6.1 APPLIED PROCEDURES / LIMIT	47
6.1.1 TEST PROCEDURE	47
6.1.2 DEVIATION FROM STANDARD	47
6.1.3 TEST SETUP	47
6.1.4 EUT OPERATION CONDITIONS	47
6.1.5 TEST RESULTS	48
7 . 100 KHZ BANDWIDTH OF FREQUENCY BAND EDGE	49
7.1 DEVIATION FROM STANDARD	49
7.2 TEST SETUP	49
7.3 EUT OPERATION CONDITIONS	49
7.4 TEST RESULTS	50
8 . ANTENNA REQUIREMENT	54
8.1 STANDARD REQUIREMENT	54
8.2 EUT ANTENNA	54
9 . EUT TEST PHOTO	55
APPENDIX-PHOTOGRAPHS OF EUT CONSTRUCTIONAL DETAILS	



1. SUMMARY OF TEST RESULTS

Test procedures according to the technical standards:

FCC Part15 (15.247) , Subpart C			
Standard Section	Test Item	Judgment	Remark
15.207	Conducted Emission	PASS	
15.247 (a)(2)	6dB Bandwidth	PASS	
15.247 (b)	Peak Output Power	PASS	
15.247 (c)	Radiated Spurious Emission	PASS	
15.247 (d)	Power Spectral Density	PASS	
15.205	Band Edge Emission	PASS	
15.203	Antenna Requirement	PASS	

NOTE:

(1) "N/A" denotes test is not applicable in this Test Report



1.1 TEST FACILITY

Shenzhen BCTC Technology Co., Ltd

Add.: No.101,Youshong Road,Longhua New District, Shenzhen,China

FCC Registration No.: 187086

1.2 MEASUREMENT UNCERTAINTY

The reported uncertainty of measurement $y \pm U$, where expanded uncertainty U is based on a standard uncertainty multiplied by a coverage factor of $k=2$, providing a level of confidence of approximately 95 %.

No.	Item	Uncertainty
1	Conducted Emission Test	$\pm 1.38\text{dB}$
2	RF power,conducted	$\pm 0.16\text{dB}$
3	Spurious emissions,conducted	$\pm 0.21\text{dB}$
4	All emissions,radiated(<1G)	$\pm 4.68\text{dB}$
5	All emissions,radiated(>1G)	$\pm 4.89\text{dB}$
6	Temperature	$\pm 0.5^{\circ}\text{C}$
7	Humidity	$\pm 2\%$

2. GENERAL INFORMATION

2.1 GENERAL DESCRIPTION OF EUT

Equipment	WIFI Module
Trade Name	N/A
Model Name	ESP-12
Serial Model	M750, M752, M711, M712, M777, M778, M720, M721, M776, M756, M9000, M9100, M9200
Model Difference	All the models are the same circuit and RF module, except the model names.
Modulation Type:	802.11b: DSSS (CCK, DQPSK, DBPSK) 802.11g/n(20): DSSS (CCK, DQPSK, DBPSK)+OFDM (QPSK, BPSK, 16-QAM, 64-QAM)
Bit Rate of Transmitter	802.11b: 11/5.5/2/1 Mbps 802.11g: 54/48/36/24/18/12/9/6Mbps 802.11n: 65/52/6.5Mbps
Operation Frequency:	802.11b/g/n: 2412~2462 MHz
Output Power(Conducted):	802.11b: 15.61 dBm (Max.) 802.11g: 13.79 dBm (Max.) 802.11n: 12.78 dBm (Max.)
Antenna Gain (dBi)	1.0dbi
Channel List	Please refer to the Note 2.
Adapter(Ancillary Equipment)	Model: LSD-D051100 INPUT: 100-240V~, 50/60Hz, 0.2A OUTPUT: 5V, 1A
Control board(Ancillary Equipment)	Model: ESP-12 Manufacture : Shenzhen Anxinke technology co., LTD Power by adapter
Connecting I/O Port(s)	Please refer to the User's Manual

Note:

1. For a more detailed features description, please refer to the manufacturer's specifications or the User's Manual.

2.

Channel List for 802.11b/g/n(20)							
Channel	Frequency (MHz)	Channel	Frequency (MHz)	Channel	Frequency (MHz)	Channel	Frequency (MHz)
01	2412	04	2427	07	2442	10	2457
02	2417	05	2432	08	2447	11	2462
03	2422	06	2437	09	2452		



3.

Table for Filed Antenna

Ant	Brand	Model Name	Antenna Type	Connector	Gain (dBi)	NOTE
A	N/A	N/A	PCB Antenna	N/A	1.0	Wifi Antenna

2.2 DESCRIPTION OF TEST MODES

To investigate the maximum EMI emission characteristics generates from EUT, the test system was pre-scanning tested base on the consideration of following EUT operation mode or test configuration mode which possible have effect on EMI emission level. Each of these EUT operation mode(s) or test configuration mode(s) mentioned above was evaluated respectively.

Pretest Mode	Description
Mode 1	802.11b CH1/ CH6/ CH11
Mode 2	802.11g CH1/ CH6/ CH11
Mode 3	802.11n CH1/ CH6/ CH11
Mode 4	Link Mode

For Conducted Emission	
Final Test Mode	Description
Mode 4	Link Mode

For Radiated Emission	
Final Test Mode	Description
Mode 1	802.11b CH1/ CH6/ CH11
Mode 2	802.11g CH1/ CH6/ CH11
Mode 3	802.11n CH1/ CH6/ CH11

Note:

- (1) The measurements are performed at the highest, middle, lowest available channels.
- (2) The measurements are performed at all Bit Rate of Transmitter, the worst data was reported

2.3 BLOCK DIGRAM SHOWING THE CONFIGURATION OF SYSTEM TESTED

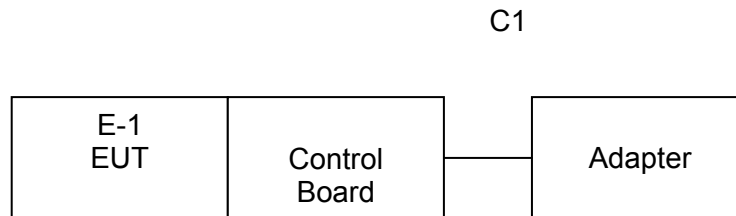

NOTE: The control board can control the WIFI module to transmit signal.

2.4 DESCRIPTION OF SUPPORT UNITS(CONDUCTED MODE)

The EUT has been tested as an independent unit together with other necessary accessories or support units. The following support units or accessories were used to form a representative test configuration during the tests.

Item	Equipment	Brand	Model/Type No.	Series No.	Note
E-1	WIFI Module	ESP	ESP-12	N/A	EUT

Item	Shielded Type	Ferrite Core	Length	Note
C-1	NO	NO	1.0m	

Note:

- (1) The support equipment was authorized by Declaration of Confirmation.
- (2) For detachable type I/O cable should be specified the length in cm in 『Length』 column.
- (3) The EUT was programmed to be in continuously transmitting mode and the transmit duty cycle is not less than 98%.

2.5 EQUIPMENTS LIST FOR ALL TEST ITEMS

Radiation Test equipment

Item	Kind of Equipment	Manufacturer	Type No.	Serial No.	Last calibration	Calibrated until	Calibration period
1	Spectrum Analyzer	Agilent	E4407B	MY45108040	2014.07.06	2015.07.05	1 year
2	Test Receiver	R&S	ESPI	101318	2014.06.07	2015.06.06	1 year
3	Bilog Antenna	TESEQ	CBL6111D	31216	2014.07.06	2015.07.05	1 year
4	50Ω Coaxial Switch	Anritsu	MP59B	6200264416	2014.06.07	2015.06.06	1 year
5	Spectrum Analyzer	ADVANTEST	R3132	150900201	2014.06.07	2015.06.06	1 year
6	Horn Antenna	EM	EM-AH-10180	2011071402	2014.07.06	2015.07.05	1 year
7	Horn Ant	Schwarzbeck	BBHA 9170	9170-181	2014.07.06	2015.07.05	1 year
8	Amplifier	EM	EM-30180	060538	2014.12.22	2015.12.21	1 year
9	Loop Antenna	ARA	PLA-1030/B	1029	2014.06.08	2015.06.07	1 year
10	Power Meter	R&S	NRVS	100696	2014.07.06	2015.07.05	1 year
11	Power Sensor	R&S	URV5-Z4	0395.1619.05	2014.07.06	2015.07.05	1 year
12	RF cables	R&S	N/A	N/A	2014.07.06	2015.07.05	1 year

Conduction Test equipment

Item	Kind of Equipment	Manufacturer	Type No.	Serial No.	Last calibration	Calibrated until	Calibration period
1	Test Receiver	R&S	ESCI	101160	2014.06.06	2015.06.05	1 year
2	LISN	R&S	ENV216	101313	2014.08.24	2015.08.23	1 year
3	LISN	EMCO	3816/2	00042990	2014.08.24	2015.08.23	1 year
4	50Ω Coaxial Switch	Anritsu	MP59B	6200264417	2014.06.07	2015.06.06	1 year
5	Passive Voltage Probe	R&S	ESH2-Z3	100196	2014.06.07	2015.06.06	1 year
6	Absorbing clamp	R&S	MOS-21	100423	2014.06.08	2015.06.07	1 year
7	RF cables	R&S	N/A	N/A	2014.07.06	2015.07.05	1 year

3. EMC EMISSION TEST

3.1 CONDUCTED EMISSION MEASUREMENT

3.1.1 POWER LINE CONDUCTED EMISSION Limits (Frequency Range 150KHz-30MHz)

FREQUENCY (MHz)	Class A (dBuV)		Class B (dBuV)		Standard
	Quasi-peak	Average	Quasi-peak	Average	
0.15 -0.5	79.00	66.00	66 - 56 *	56 - 46 *	CISPR
0.50 -5.0	73.00	60.00	56.00	46.00	CISPR
5.0 -30.0	73.00	60.00	60.00	50.00	CISPR

0.15 -0.5	79.00	66.00	66 - 56 *	56 - 46 *	FCC
0.50 -5.0	73.00	60.00	56.00	46.00	FCC
5.0 -30.0	73.00	60.00	60.00	50.00	FCC

Note:

- (1) The tighter limit applies at the band edges.
- (2) The limit of " * " marked band means the limitation decreases linearly with the logarithm of the frequency in the range.

The following table is the setting of the receiver

Receiver Parameters	Setting
Attenuation	10 dB
Start Frequency	0.15 MHz
Stop Frequency	30 MHz
IF Bandwidth	9 kHz

3.1.2 TEST PROCEDURE

- a. The EUT was placed 0.8 meters from the horizontal ground plane with EUT being connected to the power mains through a line impedance stabilization network (LISN). All other support equipments powered from additional LISN(s). The LISN provide 50 Ohm/ 50uH of coupling impedance for the measuring instrument.
- b. Interconnecting cables that hang closer than 40 cm to the ground plane shall be folded back and forth in the center forming a bundle 30 to 40 cm long.
- c. I/O cables that are not connected to a peripheral shall be bundled in the center. The end of the cable may be terminated, if required, using the correct terminating impedance. The overall length shall not exceed 1 m.
- d. LISN at least 80 cm from nearest part of EUT chassis.
- e. For the actual test configuration, please refer to the related Item –EUT Test Photos.

3.1.3 DEVIATION FROM TEST STANDARD

No deviation

3.1.4 TEST SETUP

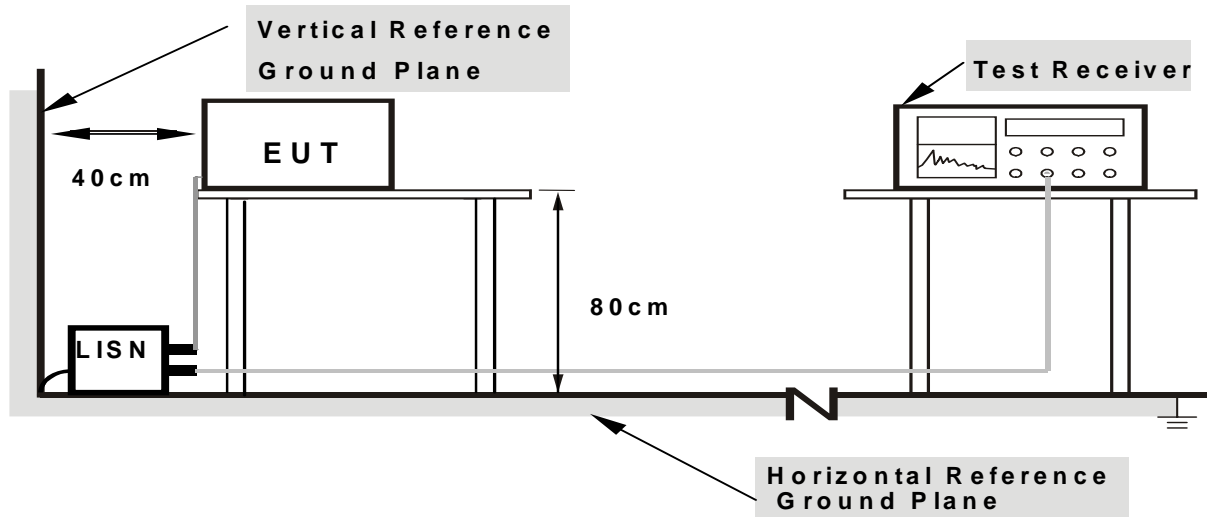

Note: 1. Support units were connected to second LISN.

2. Both of LISNs (AMN) are 80 cm from EUT and at least 80 cm from other units and other metal planes

3.1.5 EUT OPERATING CONDITIONS

The EUT was configured for testing in a typical fashion (as a customer would normally use it). The EUT has been programmed to continuously transmit during test. This operating condition was tested and used to collect the included data.

3.1.6 TEST RESULTS

EUT :	WIFI Module	Model Name. :	ESP-12
Temperature :	26 °C	Relative Humidity :	54%
Pressure :	1010hPa	Phase :	L
Test Voltage :	AC120V	Test Mode :	Mode 4

Frequency (MHz)	Reading Level (dBμV)	Correct Factor (dB)	Measure-ment (dBμV)	Limits (dBμV)	Margin (dB)	Detector Type
0.1780	48.19	9.79	57.98	64.57	-6.59	QP
0.1780	40.28	9.79	50.07	54.57	-4.50	AVG
3.9700	36.19	10.33	46.52	56.00	-9.48	QP
4.0300	31.47	10.33	41.80	46.00	-4.20	AVG

Remark:

1. All readings are Quasi-Peak and Average values.
2. Factor = Insertion Loss + Cable Loss.

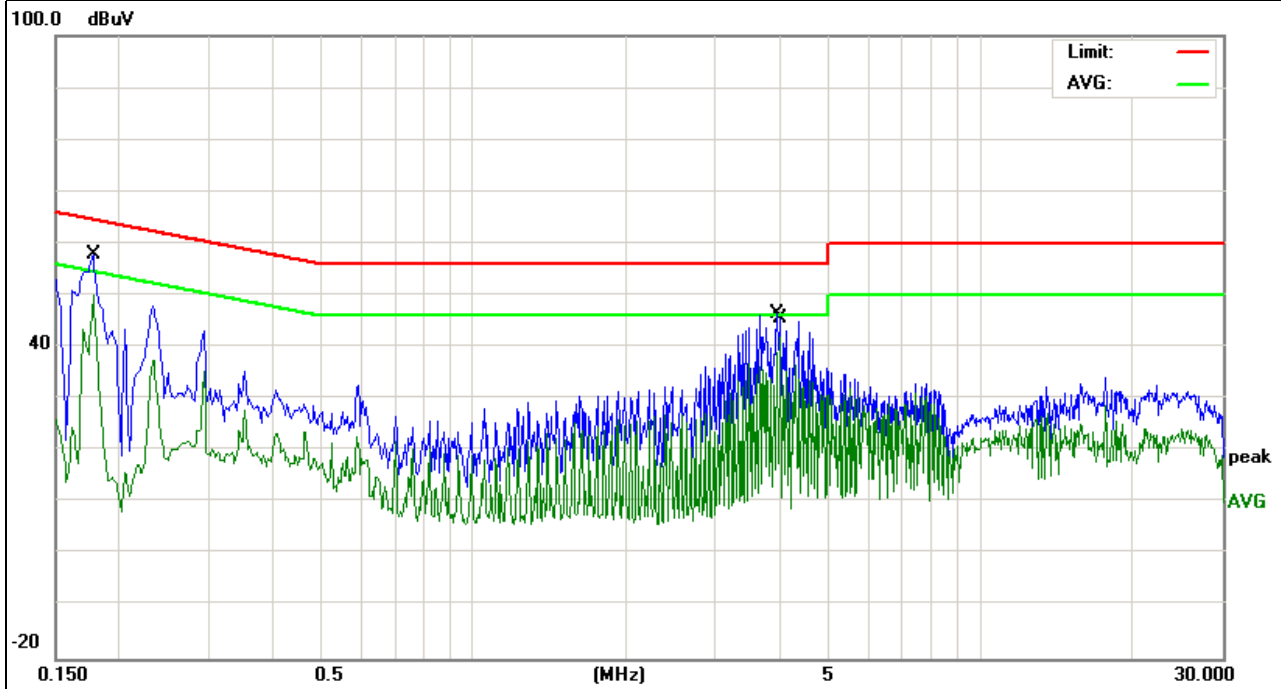

EUT :	WIFI Module	Model Name. :	ESP-12
Temperature :	26 °C	Relative Humidity :	54%
Pressure :	1010hPa	Phase :	N
Test Voltage :	AC120V	Test Mode :	Mode4

Frequency (MHz)	Reading Level (dBμV)	Correct Factor (dB)	Measure-ment (dBμV)	Limits (dBμV)	Margin (dB)	Detector Type
0.1739	44.34	9.80	54.14	64.77	-10.63	QP
0.1739	33.90	9.80	43.70	54.77	-11.07	AVG
4.2579	32.24	10.35	42.59	56.00	-13.41	QP
4.4939	25.71	10.36	36.07	46.00	-9.93	AVG

Remark:

1. All readings are Quasi-Peak and Average values.
2. Factor = Insertion Loss + Cable Loss.

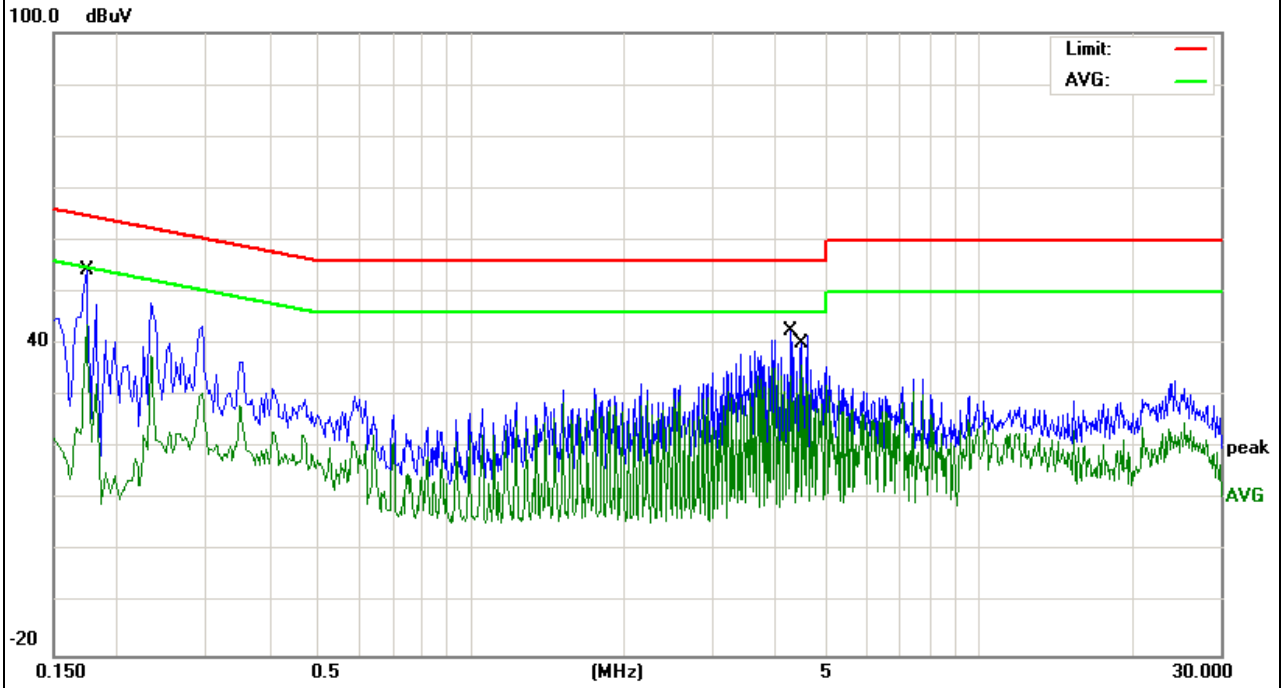

3.2 RADIATED EMISSION MEASUREMENT

3.2.1 RADIATED EMISSION LIMITS (Frequency Range 9kHz-1000MHz)

20dBc in any 100 kHz bandwidth outside the operating frequency band. In case the emission fall within the restricted band specified on 15.205(a), then the 15.209(a) limit in the table below has to be followed.

Frequencies (MHz)	Field Strength (micorvolts/meter)	Measurement Distance (meters)
0.009~0.490	2400/F(KHz)	300
0.490~1.705	24000/F(KHz)	30
1.705~30.0	30	30
30~88	100	3
88~216	150	3
216~960	200	3
Above 960	500	3

LIMITS OF RADIATED EMISSION MEASUREMENT (Above 1000MHz)

FREQUENCY (MHz)	Class A (dBuV/m) (at 3M)		Class B (dBuV/m) (at 3M)	
	PEAK	AVERAGE	PEAK	AVERAGE
Above 1000	80	60	74	54

Notes:

- (1) The limit for radiated test was performed according to FCC PART 15C.
- (2) The tighter limit applies at the band edges.
- (3) Emission level (dBuV/m)=20log Emission level (uV/m).

Spectrum Parameter	Setting
Attenuation	Auto
Start Frequency	1000 MHz
Stop Frequency	10th carrier harmonic
RB / VB (emission in restricted band)	1 MHz / 1 MHz for Peak, 1 MHz / 10Hz for Average

Receiver Parameter	Setting
Attenuation	Auto
Start ~ Stop Frequency	9kHz~150kHz / RB 200Hz for QP
Start ~ Stop Frequency	150kHz~30MHz / RB 9kHz for QP
Start ~ Stop Frequency	30MHz~1000MHz / RB 120kHz for QP

3.2.2 TEST PROCEDURE

- a. The measuring distance of at 3 m shall be used for measurements at frequency up to 1GHz. For frequencies above 1GHz, any suitable measuring distance may be used.
- b. The EUT was placed on the top of a rotating table 0.8 meters above the ground at a 3 meter open area test site. The table was rotated 360 degrees to determine the position of the highest radiation.
- c. The height of the equipment or of the substitution antenna shall be 0.8 m; the height of the test antenna shall vary between 1 m to 4 m. Both horizontal and vertical polarizations of the antenna are set to make the measurement.
- d. The initial step in collecting conducted emission data is a spectrum analyzer peak detector mode pre-scanning the measurement frequency range. Significant peaks are then marked and then Quasi Peak detector mode re-measured.
- e. If the Peak Mode measured value compliance with and lower than Quasi Peak Mode Limit, the EUT shall be deemed to meet QP Limits and then no additional QP Mode measurement performed.
- f. For the actual test configuration, please refer to the related Item –EUT Test Photos.

Note:

Both horizontal and vertical antenna polarities were tested and performed pretest to three orthogonal axis. The worst case emissions were reported

3.2.3 DEVIATION FROM TEST STANDARD

No deviation

3.2.4 TEST SETUP

(A) Radiated Emission Test-Up Frequency Below 30MHz

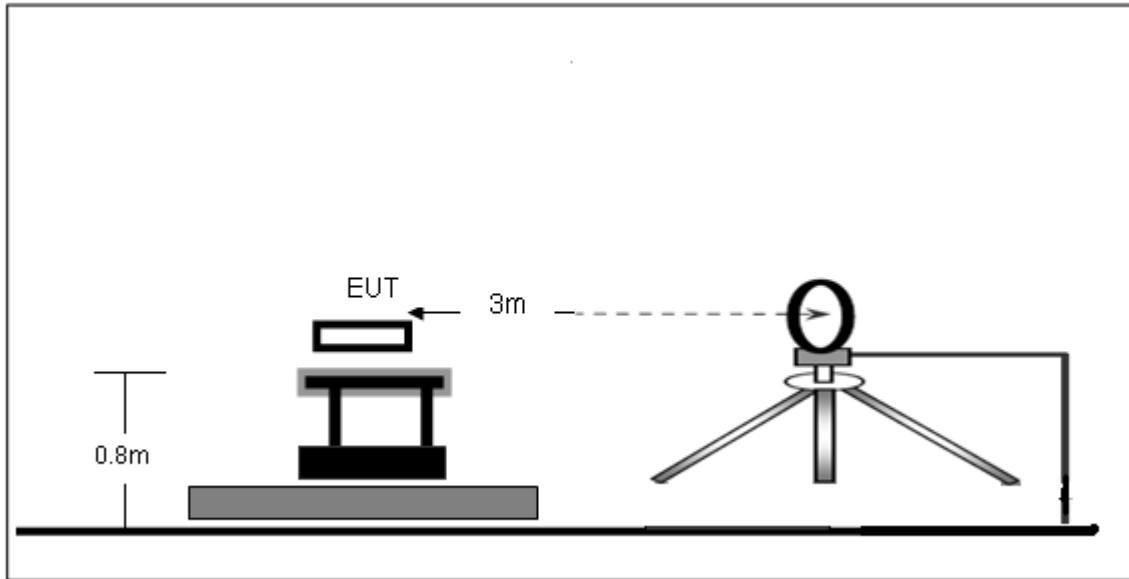

(B) Radiated Emission Test-Up Frequency 30MHz~1GHz

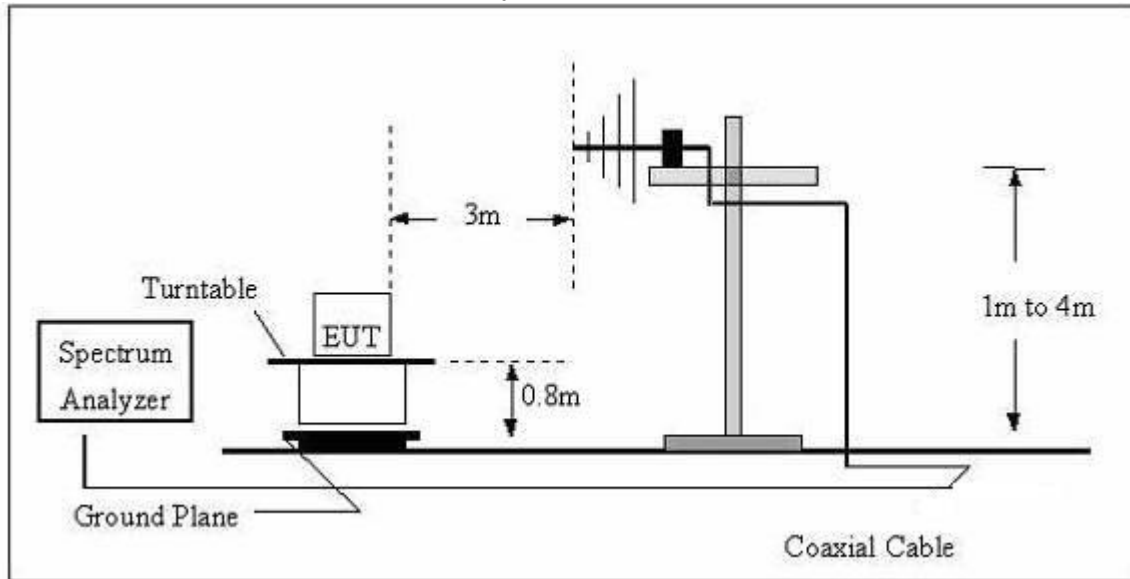

(C) Radiated Emission Test-Up Frequency Above 1GHz

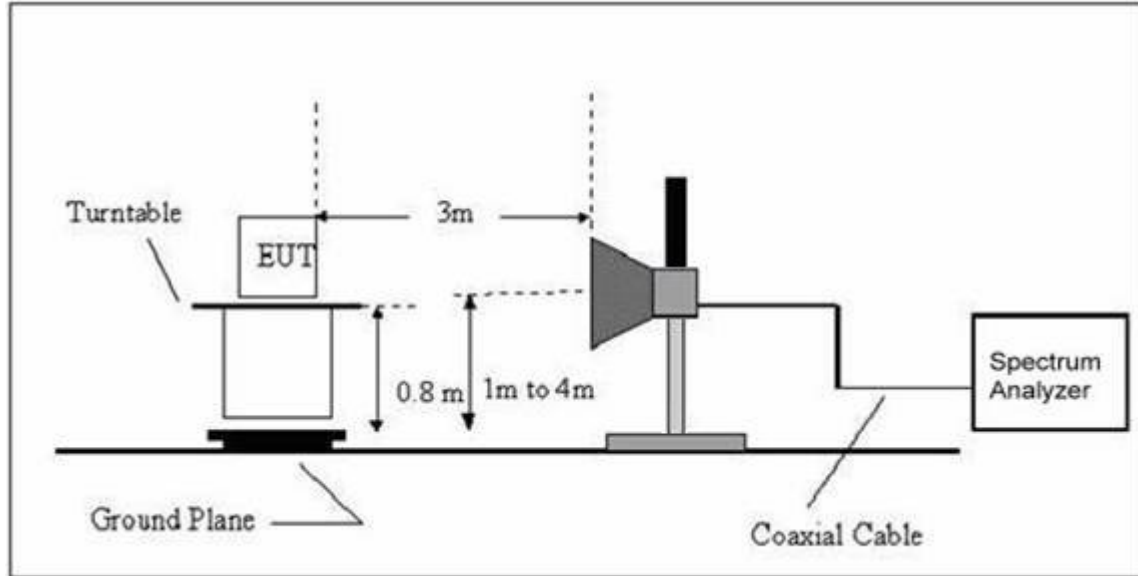

3.2.5 EUT OPERATING CONDITIONS

The EUT tested system was configured as the statements of 2.4 Unless otherwise a special operating condition is specified in the follows during the testing.

3.2.6 TEST RESULTS (BETWEEN 9KHZ – 30 MHZ)

EUT:	WIFI Module	Model Name. :	ESP-12
Temperature:	20 °C	Relative Humidity:	48%
Pressure:	1010 hPa	Test Voltage :	AC 120V
Test Mode :	TX	Polarization :	--

Freq. (MHz)	Reading (dBuV/m)	Limit (dBuV/m)	Margin (dB)	State P/F
--	--	--	--	PASS
--	--	--	--	PASS

NOTE:

The amplitude of spurious emissions which are attenuated by more than 20dB below the permissible value has no need to be reported.

Distance extrapolation factor = $40 \log (\text{specific distance}/\text{test distance})$ (dB);

Limit line = specific limits(dBuv) + distance extrapolation factor.

3.2.7 TEST RESULTS (BETWEEN 30MHZ – 1GHZ)

EUT :	WIFI Module	Model Name :	ESP-12
Temperature :	20 °C	Relative Humidity :	48%
Pressure:	1010 hPa	Test Voltage :	AC 120V
Test Mode :	TX		

Polar (H/V)	Frequency	Meter Reading	Factor	Emission Level	Limits	Margin	Detector Type
	(MHz)	(dBuV)	(dB)	(dBuV/m)	(dBuV/m)	(dB)	
V	73.3593	29.73	6.56	36.29	40.00	-3.71	QP
V	112.5241	28.24	11.79	40.03	43.50	-3.47	QP
V	167.8240	29.03	10.59	39.62	43.50	-3.88	QP
V	252.9482	27.98	13.94	41.92	46.00	-4.08	QP
V	336.0350	18.96	16.03	34.99	46.00	-11.01	QP
V	533.8318	17.52	21.58	39.10	46.00	-6.90	QP
H	76.7806	28.56	7.14	35.70	40.00	-4.30	QP
H	155.9097	27.35	11.38	38.73	43.50	-4.77	QP
H	215.2675	27.39	9.91	37.30	43.50	-6.20	QP
H	330.1949	21.14	15.85	36.99	46.00	-9.01	QP
H	416.1791	15.58	18.92	34.50	46.00	-11.50	QP
H	595.1326	14.92	22.60	37.52	46.00	-8.48	QP

Remark:

Absolute Level= ReadingLevel+ Factor, Margin= Limit- Absolute Level

**3.2.8 TEST RESULTS (ABOVE 1000 MHZ)****802.11b**

Normal Voltage

Polar (H/V)	Frequency	Meter Reading	Factor	Emission Level	Limits	Margin	Detector Type
	(MHz)	(dBuV)	(dB)	(dBuV/m)	(dBuV/m)	(dB)	
Mid Channel (2412 MHz)							
Vertical	1187.688	79.85	-18.27	61.58	74	-12.42	Pk
Vertical	1433.535	78.51	-17.12	61.39	74	-12.61	Pk
Vertical	1636.784	75.77	-16.06	59.71	74	-14.29	Pk
Vertical	4824	61.7	-3.6	58.1	74	-15.90	Pk
Vertical	4824	45.58	-3.6	41.98	54	-12.02	Pk
Horizontal	1187.688	77.03	-18.27	58.76	74	-15.24	Pk
Horizontal	2095.928	73.88	-11.88	62.00	74	-12.00	Pk
Horizontal	2412	73.83	-12.97	60.86	74	-13.14	Pk
Horizontal	2791.777	74.68	-11.65	63.03	74	-10.97	Pk
Horizontal	4824	70.77	-3.6	67.17	74	-6.83	Pk
Horizontal	4824	50.47	-3.6	46.87	54	-7.13	AV
Mid Channel (2437 MHz)							
Vertical	1187.688	82.02	-18.27	63.75	74	-10.25	Pk
Vertical	1433.535	78.48	-17.12	61.36	74	-12.64	Pk
Vertical	1636.784	75.81	-16.06	59.75	74	-14.25	Pk
Vertical	4874	66.4	-3.64	62.76	74	-11.24	Pk
Horizontal	1187.688	78.06	-18.27	59.79	74	-14.21	Pk
Horizontal	2099.687	72.59	-11.84	60.75	74	-13.25	Pk
Horizontal	2502.727	74.90	-12.73	62.17	74	-11.83	Pk
Horizontal	4874	70.19	-3.64	66.55	74	-7.45	Pk
Horizontal	4874	51.12	-3.64	47.48	54	-6.52	AV
High Channel (2462 MHz)							
Vertical	1187.688	78.2	-18.27	59.93	74	-14.07	Pk
Vertical	2133.821	69.66	-12.03	57.63	74	-16.37	Pk
Vertical	2453.883	72.17	-12.91	59.26	74	-14.74	Pk
Vertical	4924	66.36	-3.66	62.7	74	-11.30	Pk
Horizontal	1187.688	73.20	-18.27	54.93	74	-19.07	Pk
Horizontal	2133.821	69.66	-12.03	57.63	74	-16.37	Pk
Horizontal	2453.883	77.17	-12.91	64.26	74	-9.74	Pk
Horizontal	4924	66.36	-3.66	62.70	74	-11.30	Pk

Note: "802.11b" mode is the worst mode.

Conducted Spurious Emissions at Antenna Port:
802.11b Low Channel

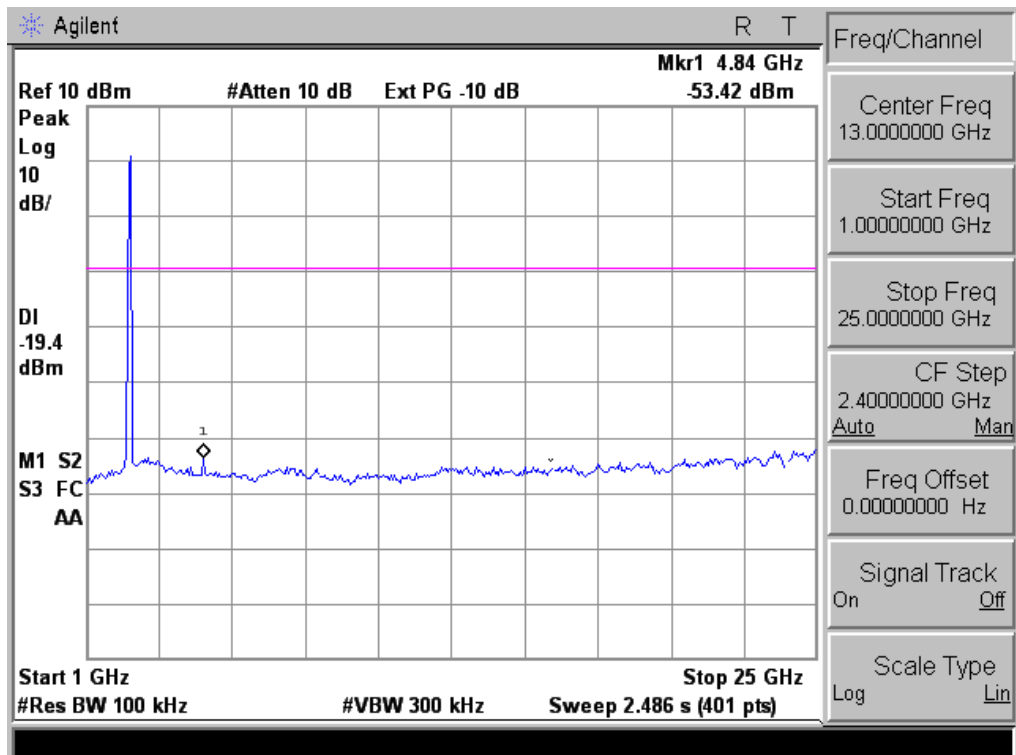
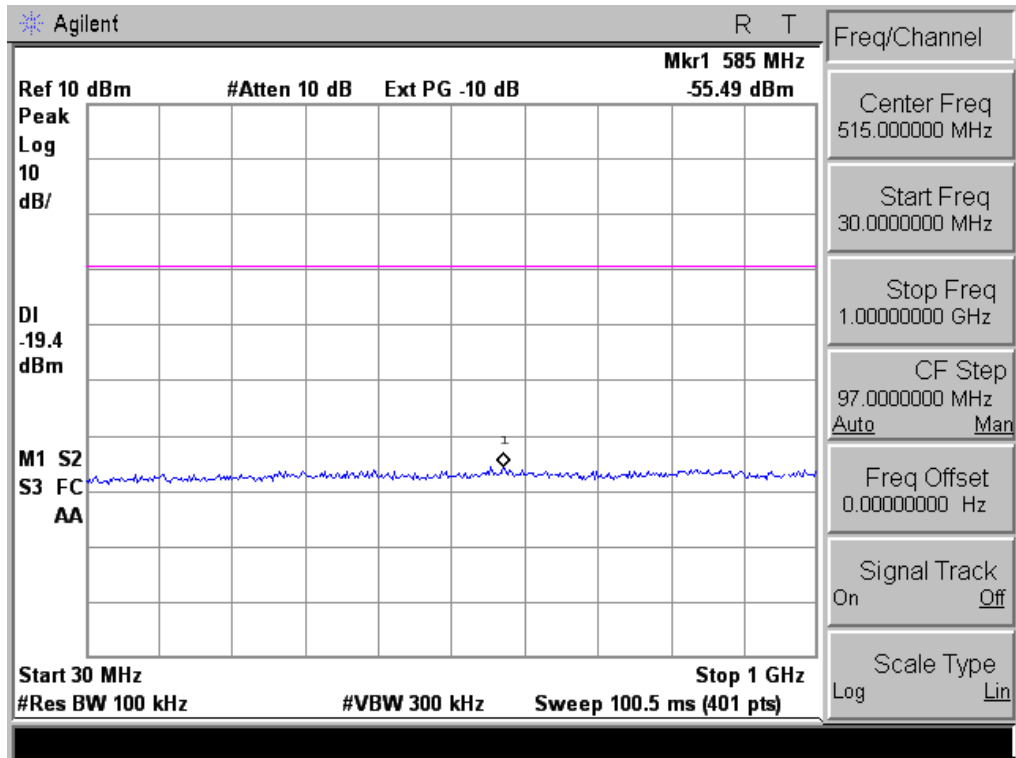



802.11b Middle Channel

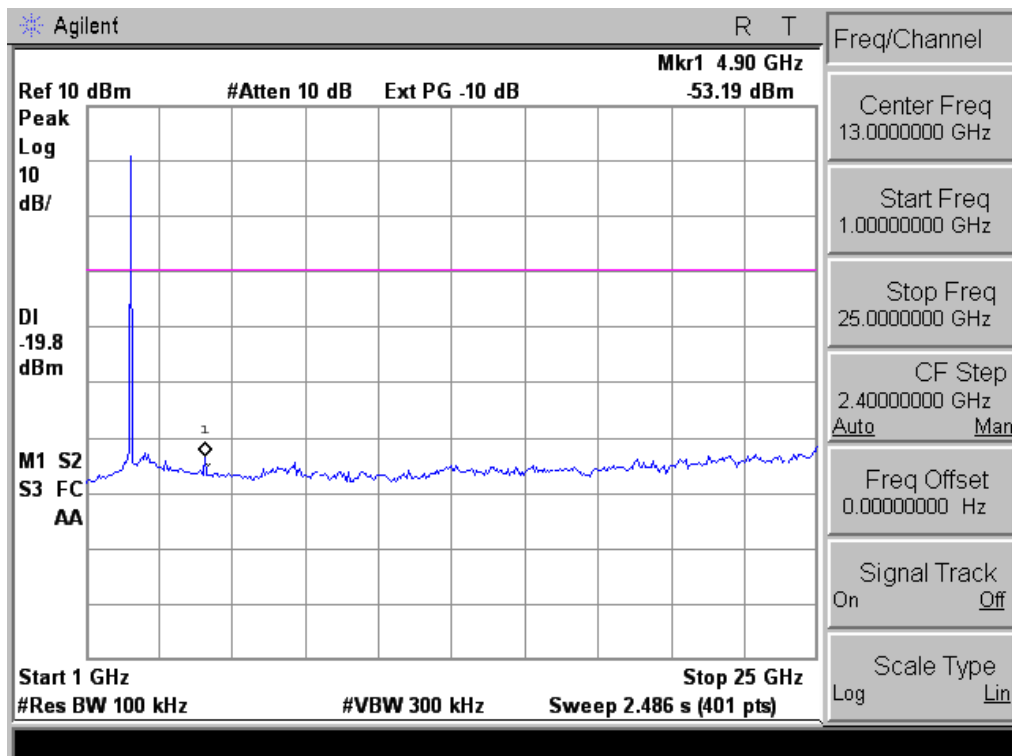
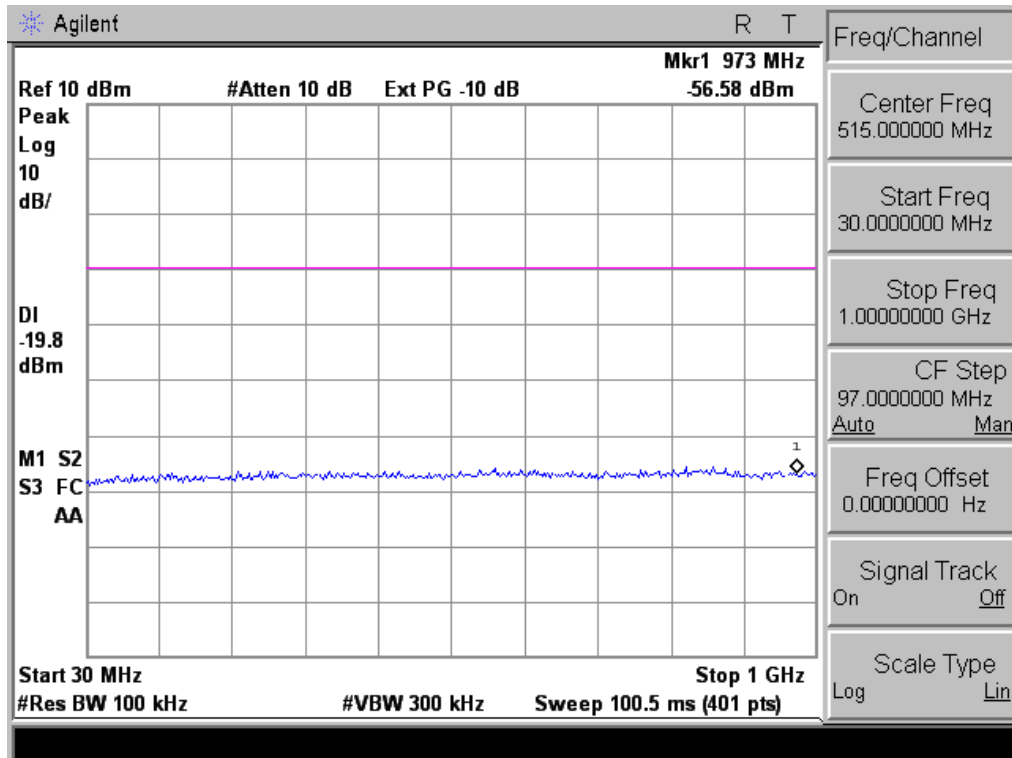



802.11b High Channel

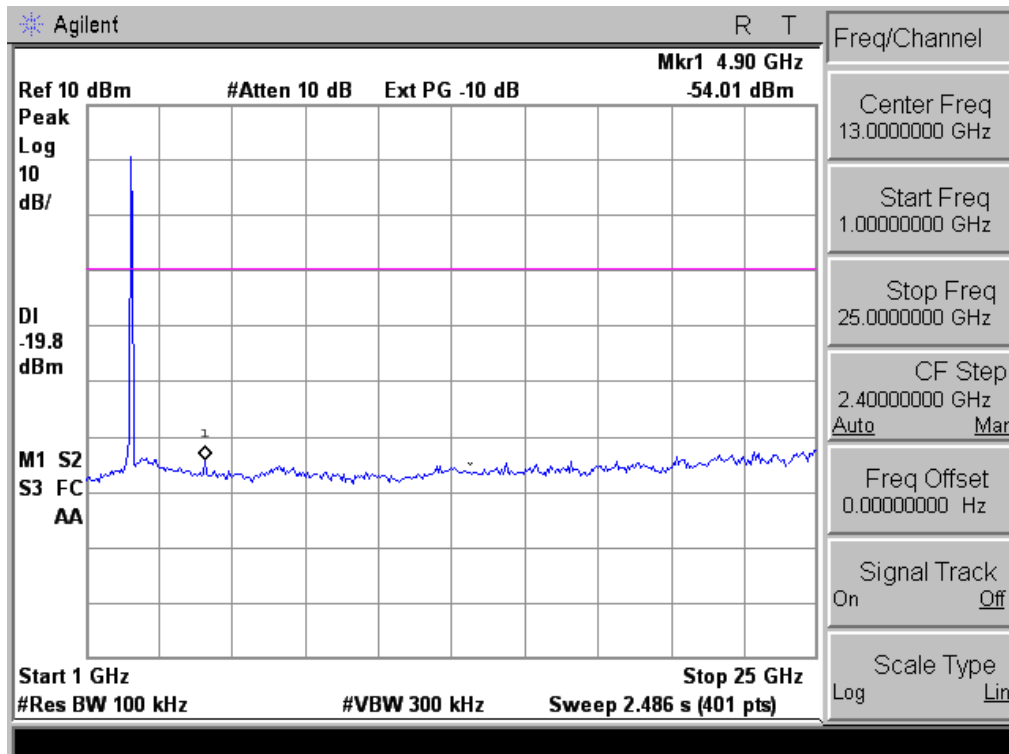
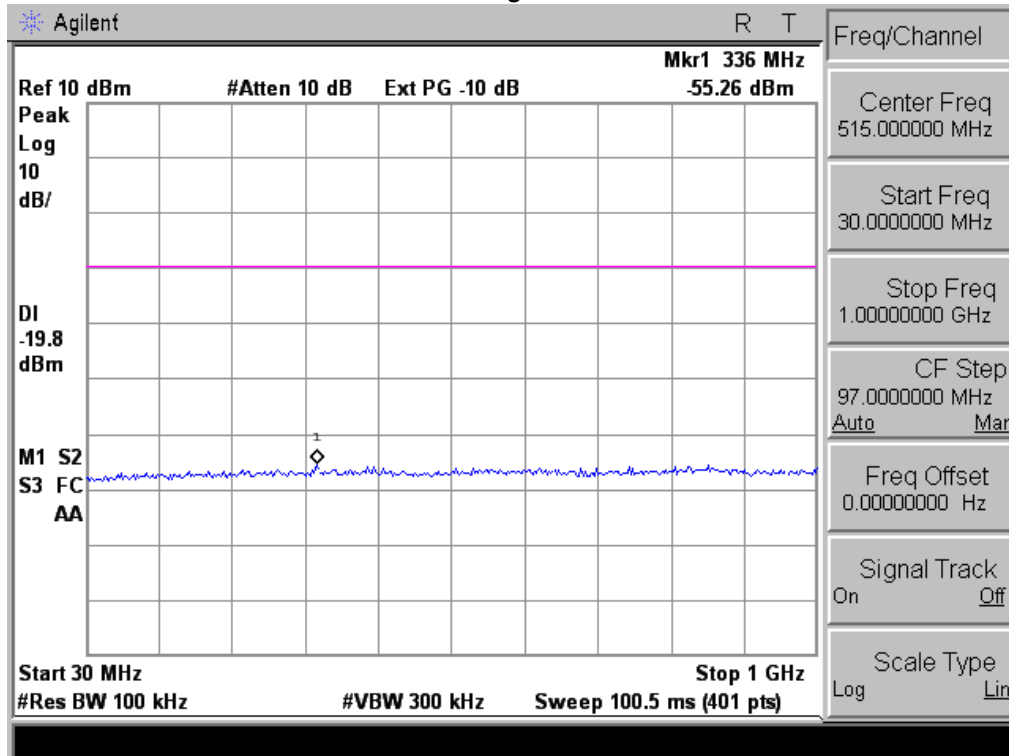



802.11g Low Channel

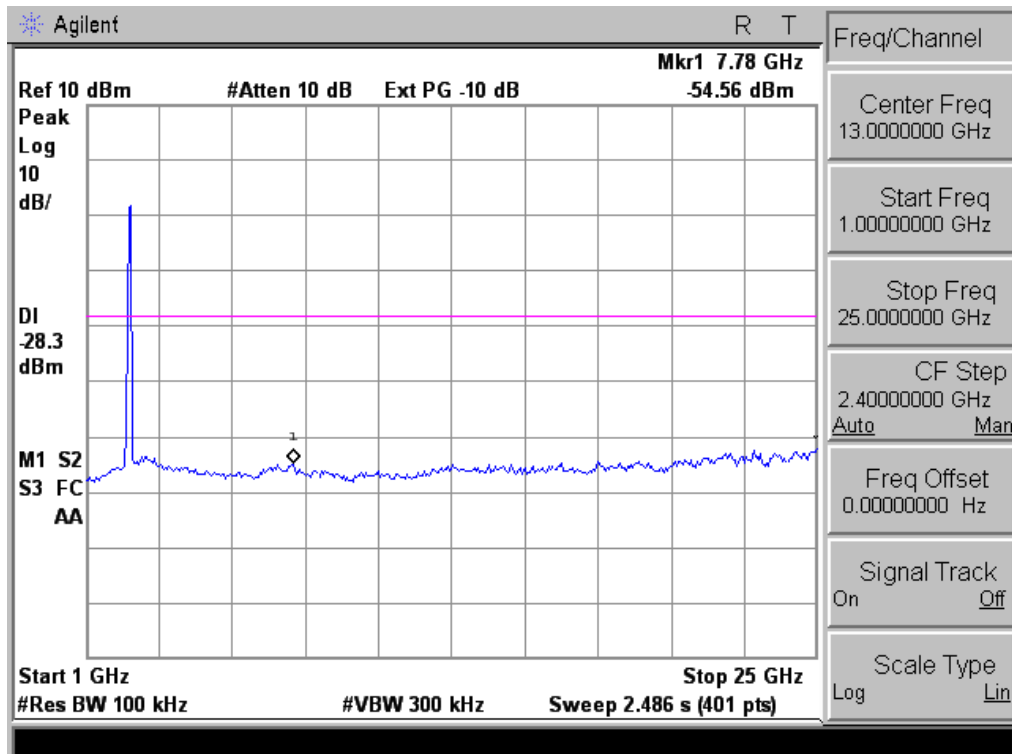
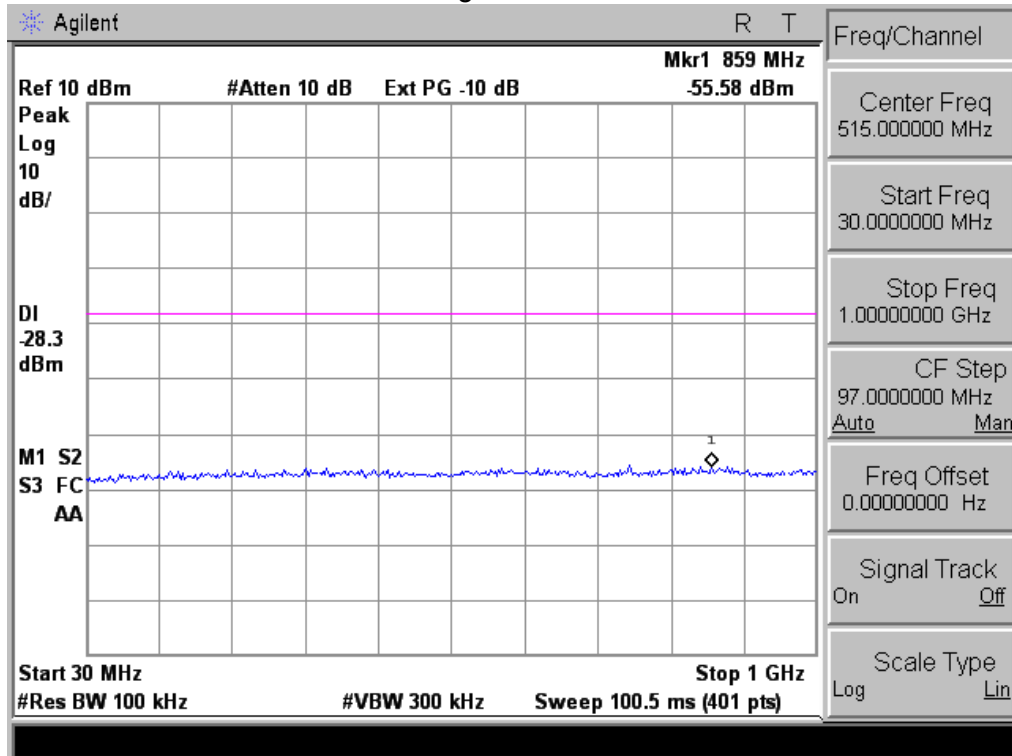



802.11g Middle Channel

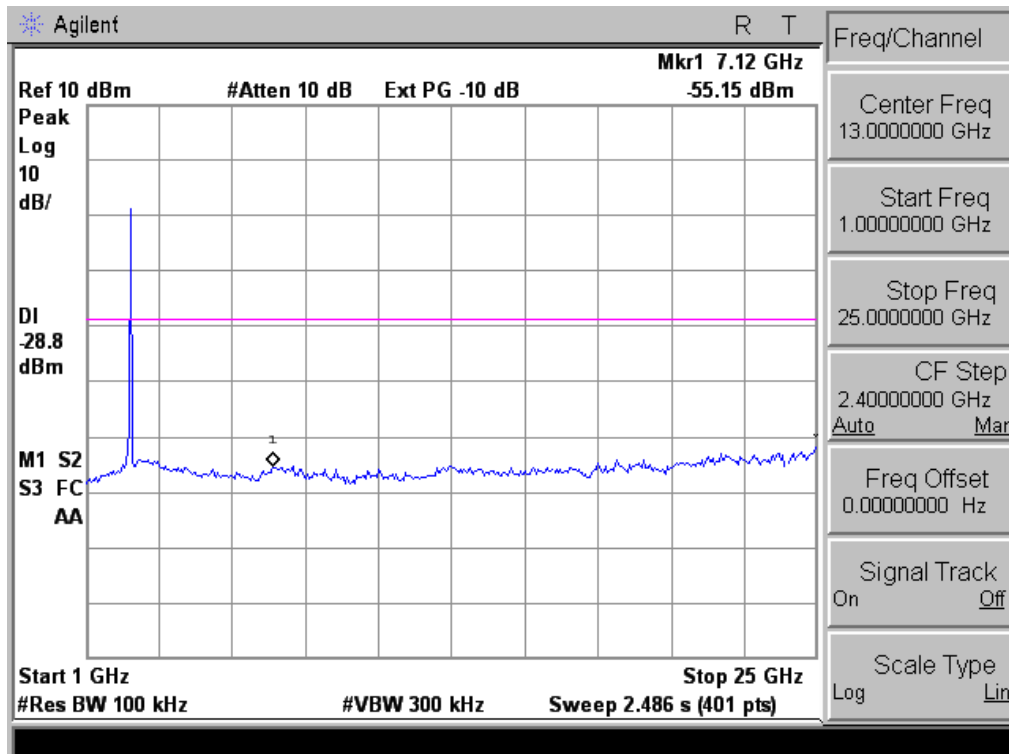
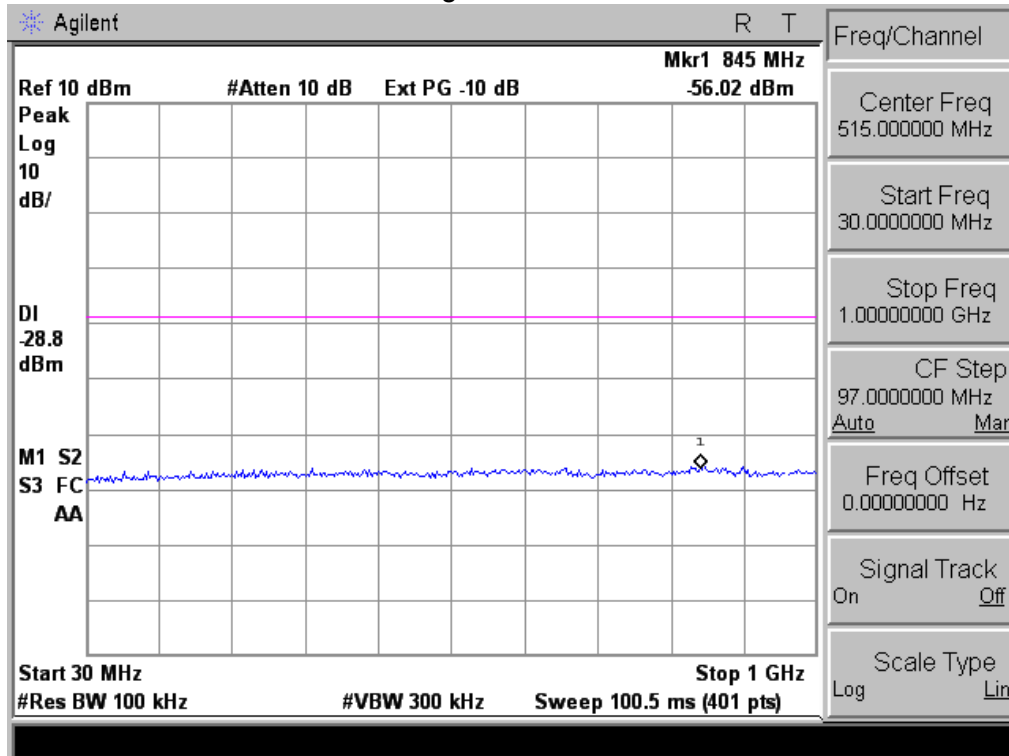



802.11g High Channel

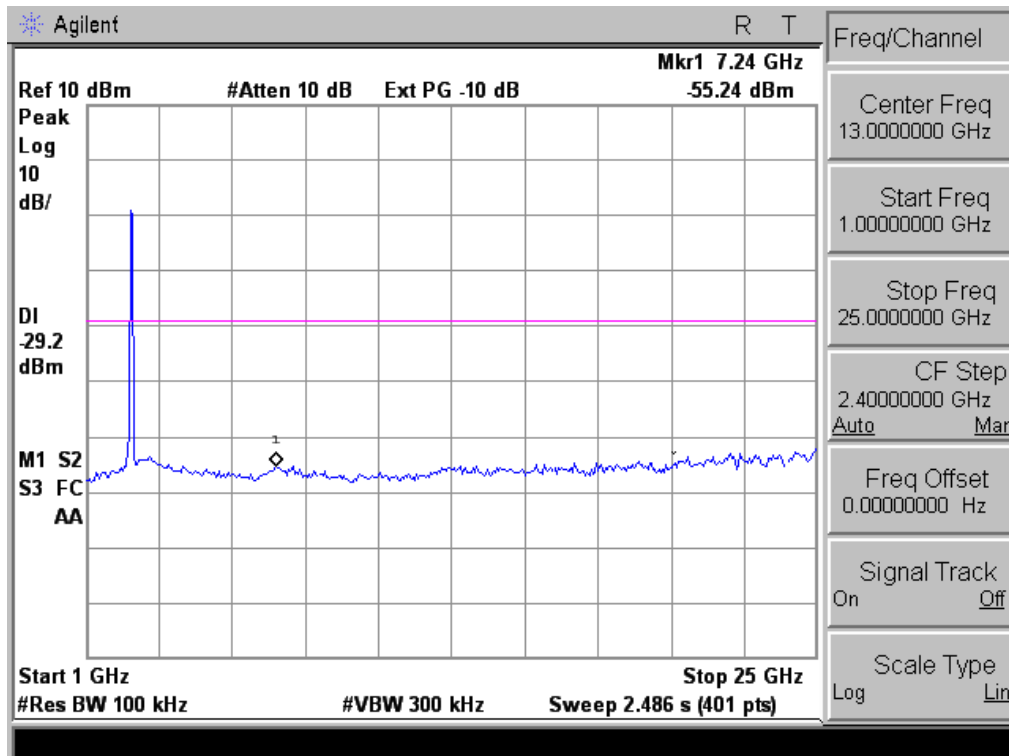
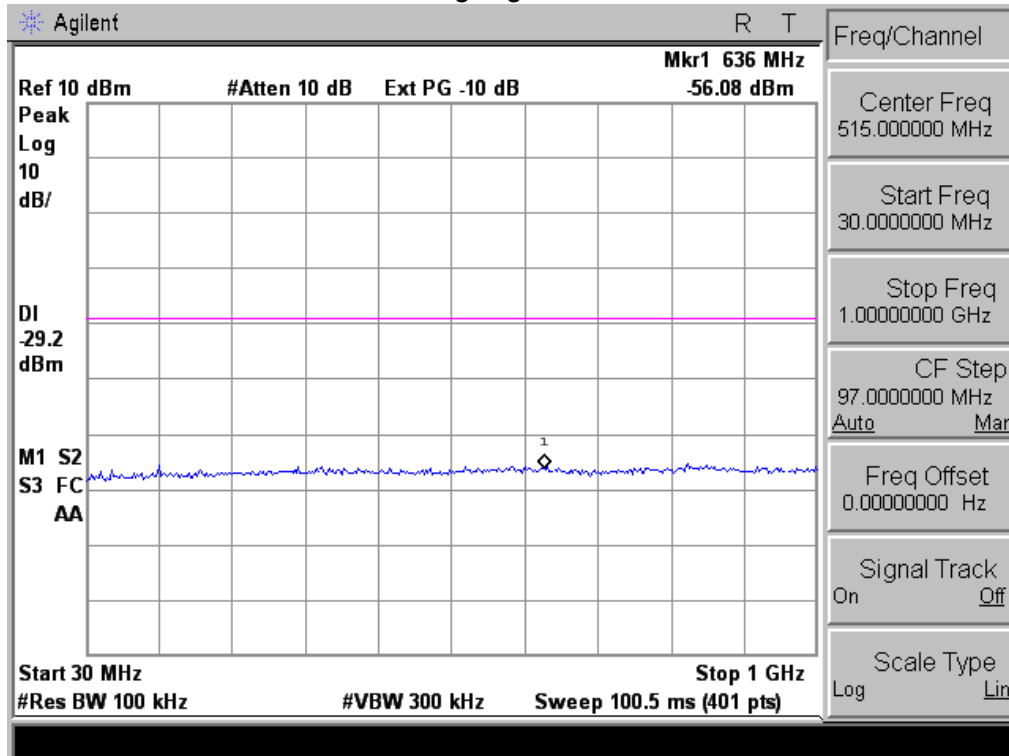



802.11n Low Channel

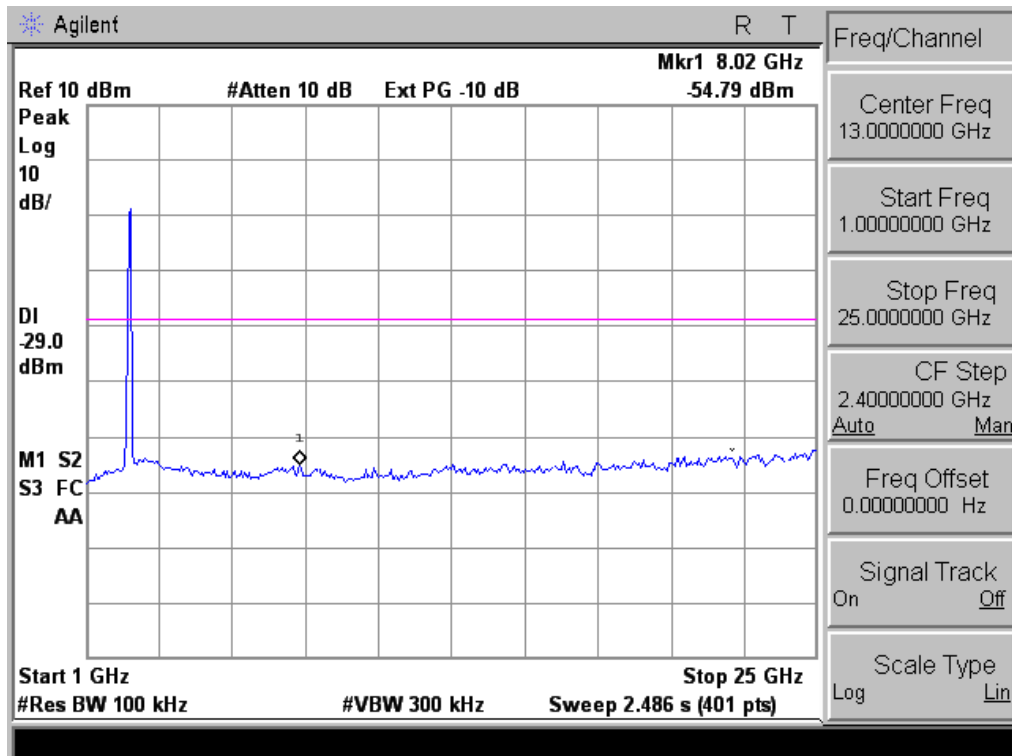
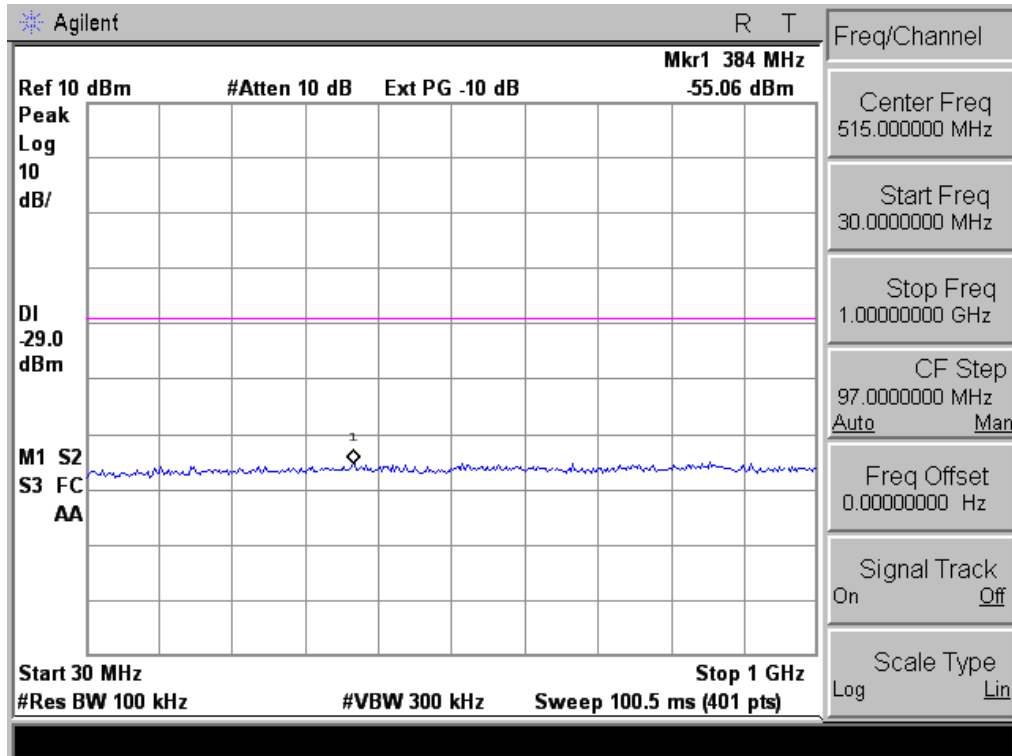



802.11n Middle Channel

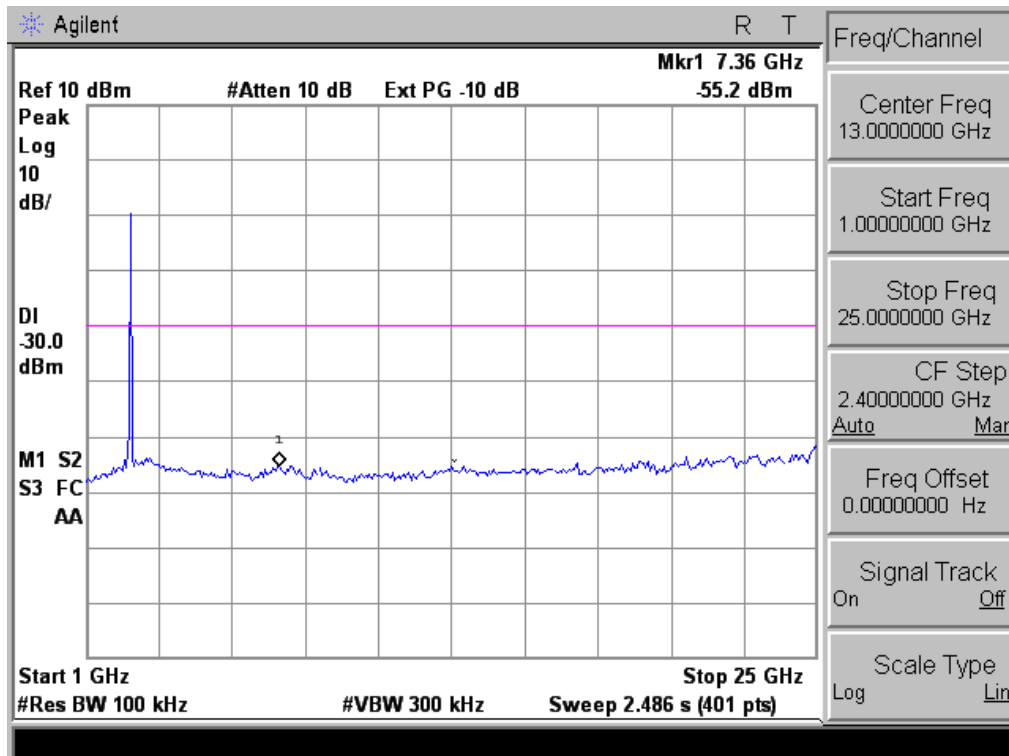
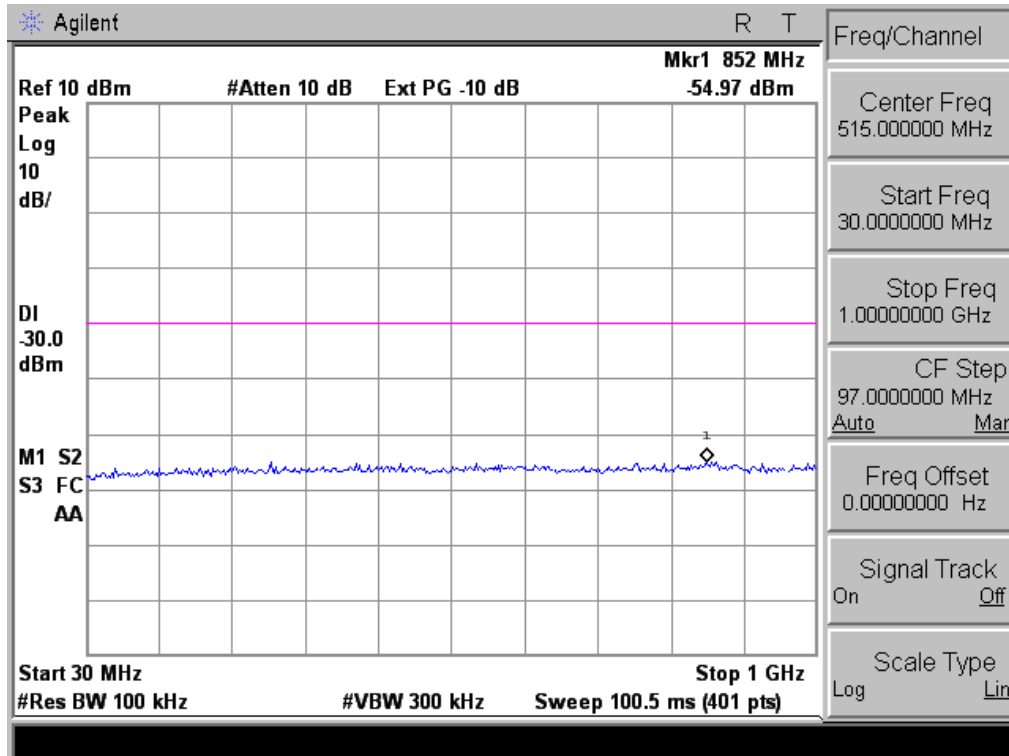



802.11n High Channel

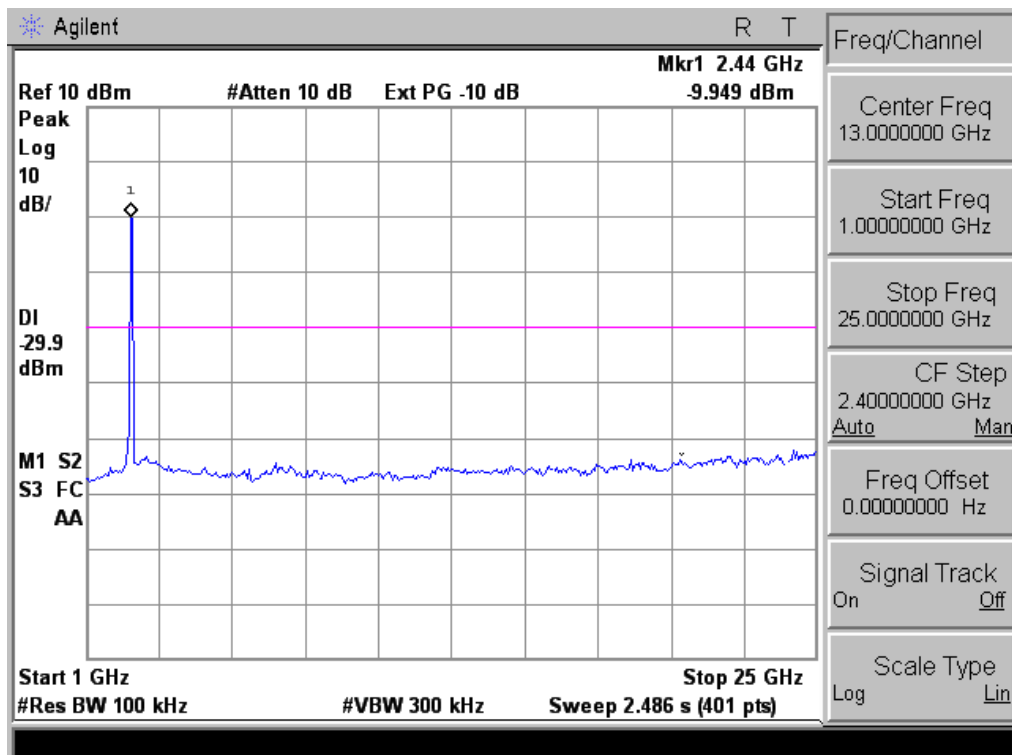
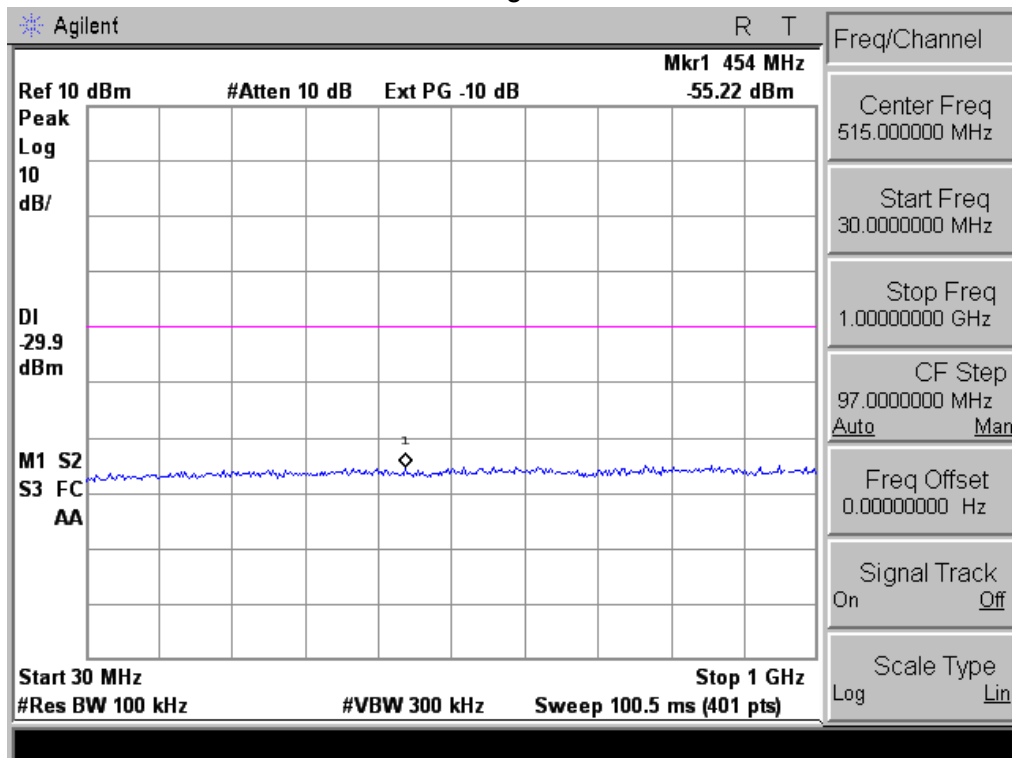

4. POWER SPECTRAL DENSITY TEST

4.1 APPLIED PROCEDURES / LIMIT

FCC Part15 (15.247) , Subpart C				
Section	Test Item	Limit	Frequency Range (MHz)	Result
15.247	Power Spectral Density	8 dBm (in any 3KHz)	2400-2483.5	PASS

4.1.1 TEST PROCEDURE

1. Set analyzer center frequency to DTS channel center frequency.
2. Set the span to 1.5 times the DTS channel bandwidth.
3. Set the RBW \geq 3 kHz.
4. Set the VBW \geq 3 x RBW.
5. Detector = peak.
6. Sweep time = auto couple.
7. Trace mode = max hold.
8. Allow trace to fully stabilize.
9. Use the peak marker function to determine the maximum amplitude level.
10. If measured value exceeds limit, reduce RBW (no less than 3 kHz) and repeat.

4.1.2 DEVIATION FROM STANDARD

No deviation.

4.1.3 TEST SETUP



4.1.4 EUT OPERATION CONDITIONS

The EUT tested system was configured as the statements of 2.1 Unless otherwise a special operating condition is specified in the follows during the testing.



4.1.5 TEST RESULTS

EUT :	WIFI Module	Model Name :	ESP-12
Temperature :	25 °C	Relative Humidity :	60%
Pressure :	1015 hPa	Test Voltage :	AC 120V
Test Mode :	TX b Mode /CH01, CH06, CH11		

Frequency	Power Density (dBm)	Limit (dBm)	Result
2412 MHz	-17.24	8	PASS
2437 MHz	-17.68	8	PASS
2462 MHz	-17.10	8	PASS

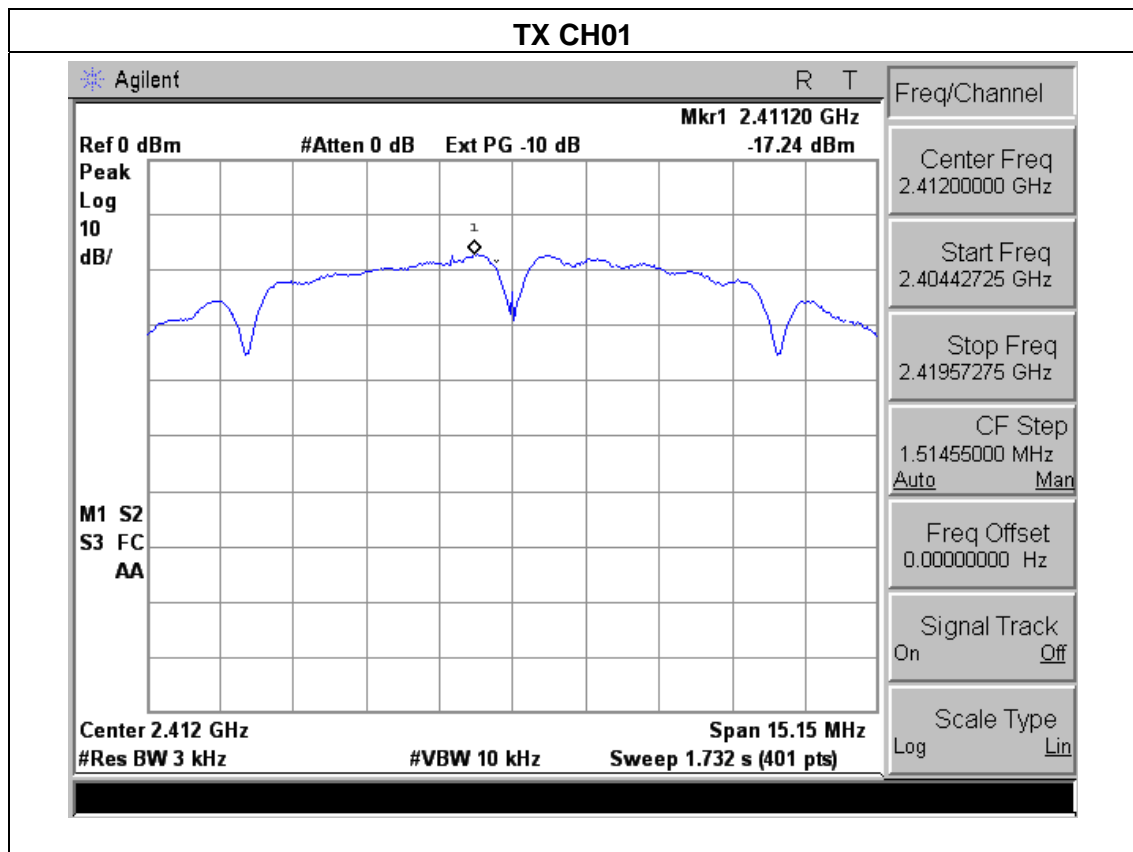

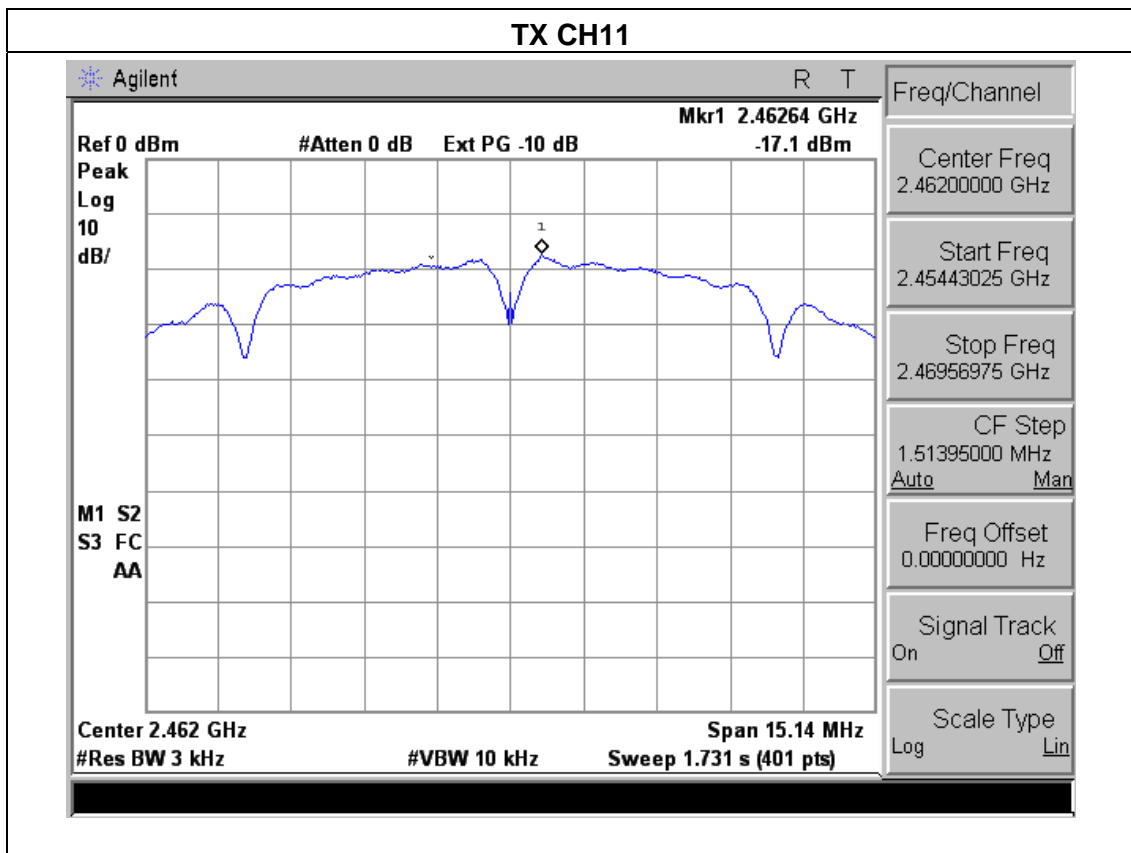
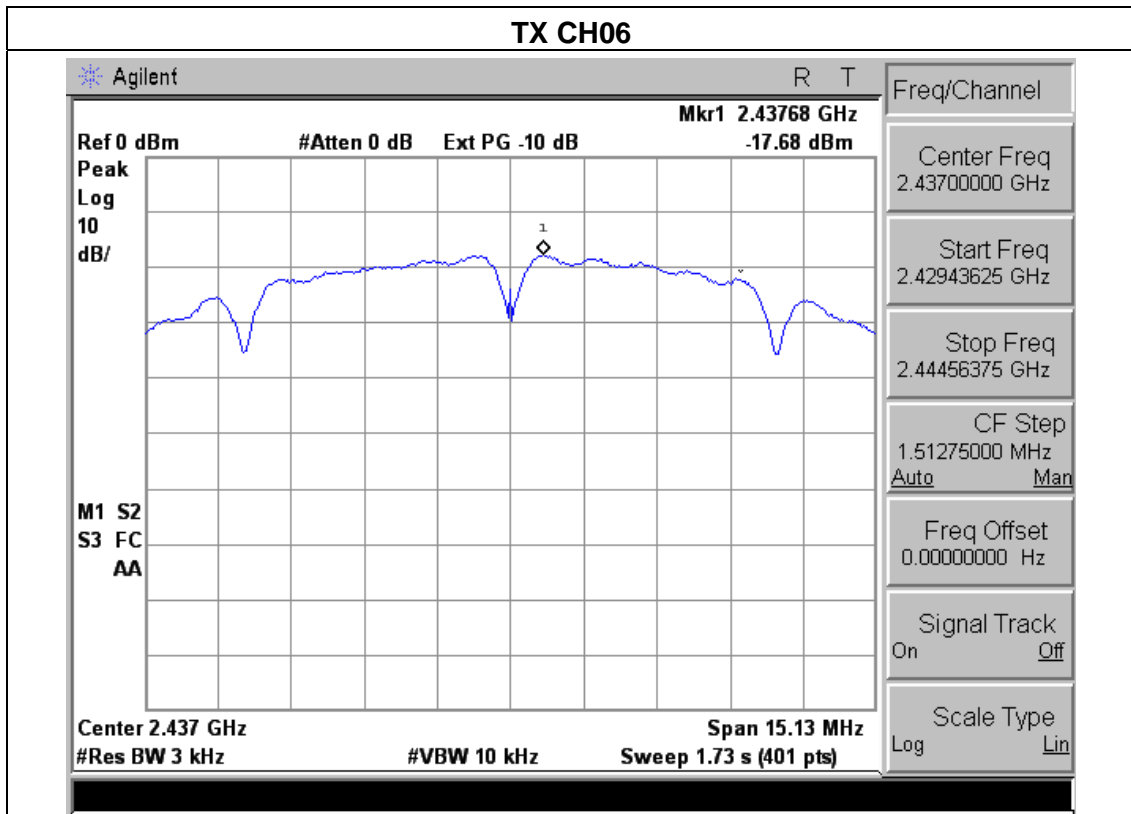



EUT :	WIFI Module	Model Name :	ESP-12
Temperature :	25 °C	Relative Humidity :	60%
Pressure :	1015 hPa	Test Voltage :	AC 120V
Test Mode :	TX g Mode /CH01, CH06, CH11		

Frequency	Power Density (dBm)	Limit (dBm)	Result
2412 MHz	-22.99	8	PASS
2437 MHz	-22.18	8	PASS
2462 MHz	-22.36	8	PASS

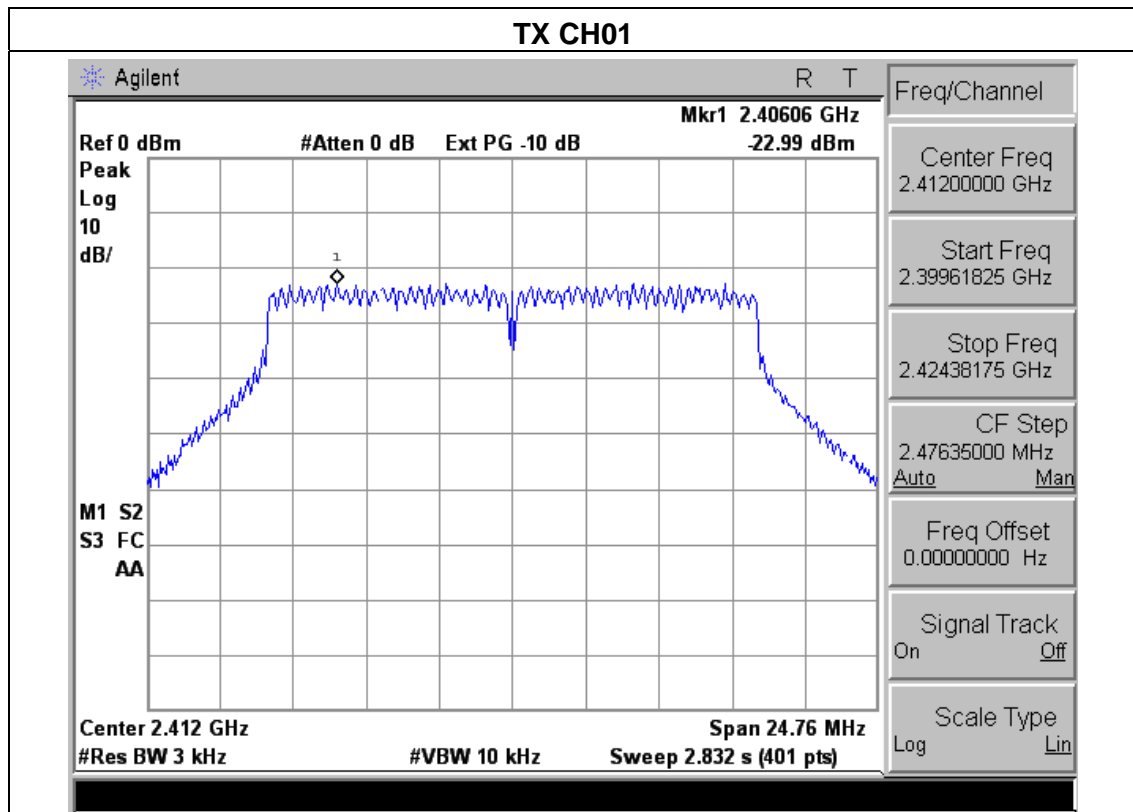

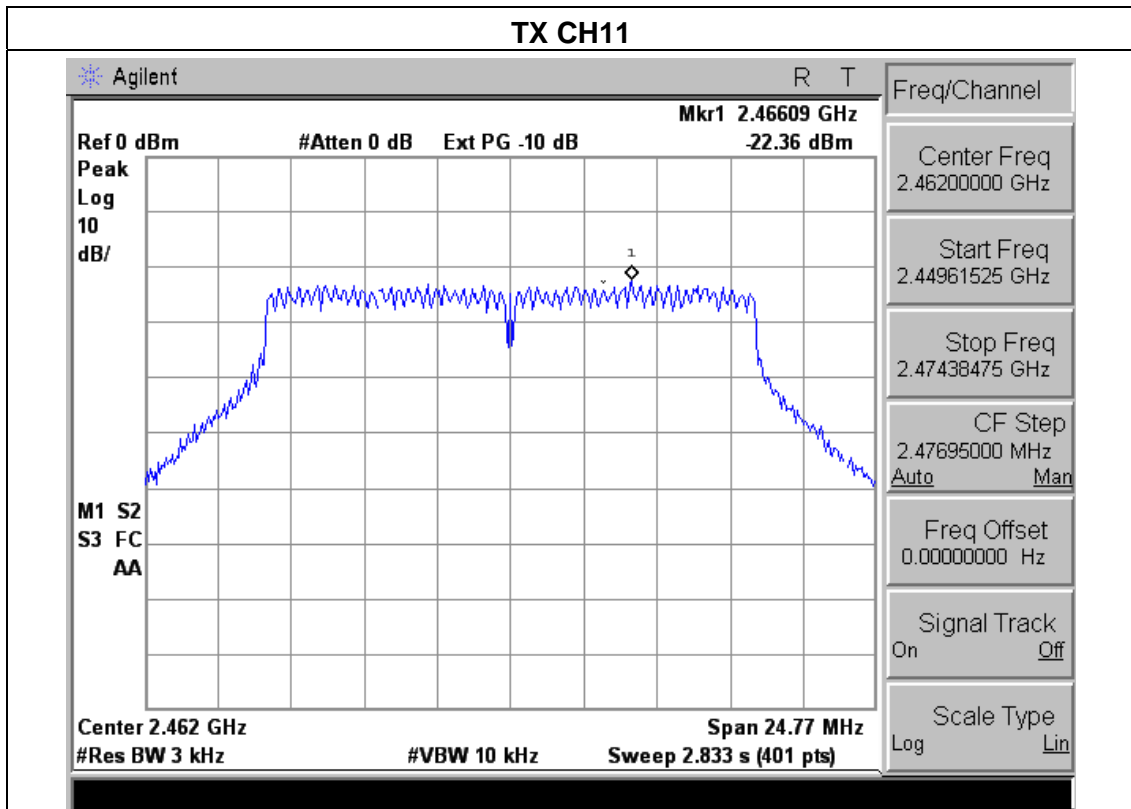
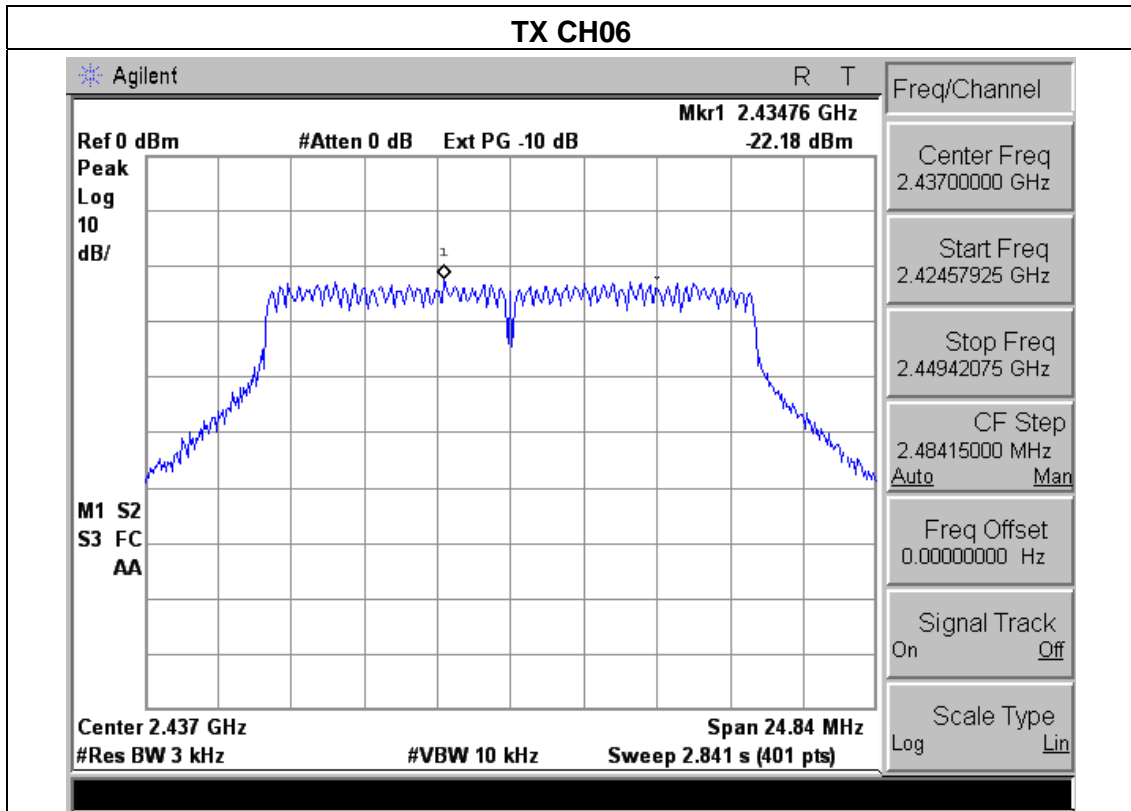



EUT :	WIFI Module	Model Name :	ESP-12
Temperature :	25 °C	Relative Humidity :	60%
Pressure :	1015 hPa	Test Voltage :	AC 120V
Test Mode :	TX n Mode /CH01, CH06, CH11		

Frequency	Power Density (dBm)	Limit (dBm)	Result
2412 MHz	-21.87	8	PASS
2437 MHz	-21.97	8	PASS
2462 MHz	-21.87	8	PASS

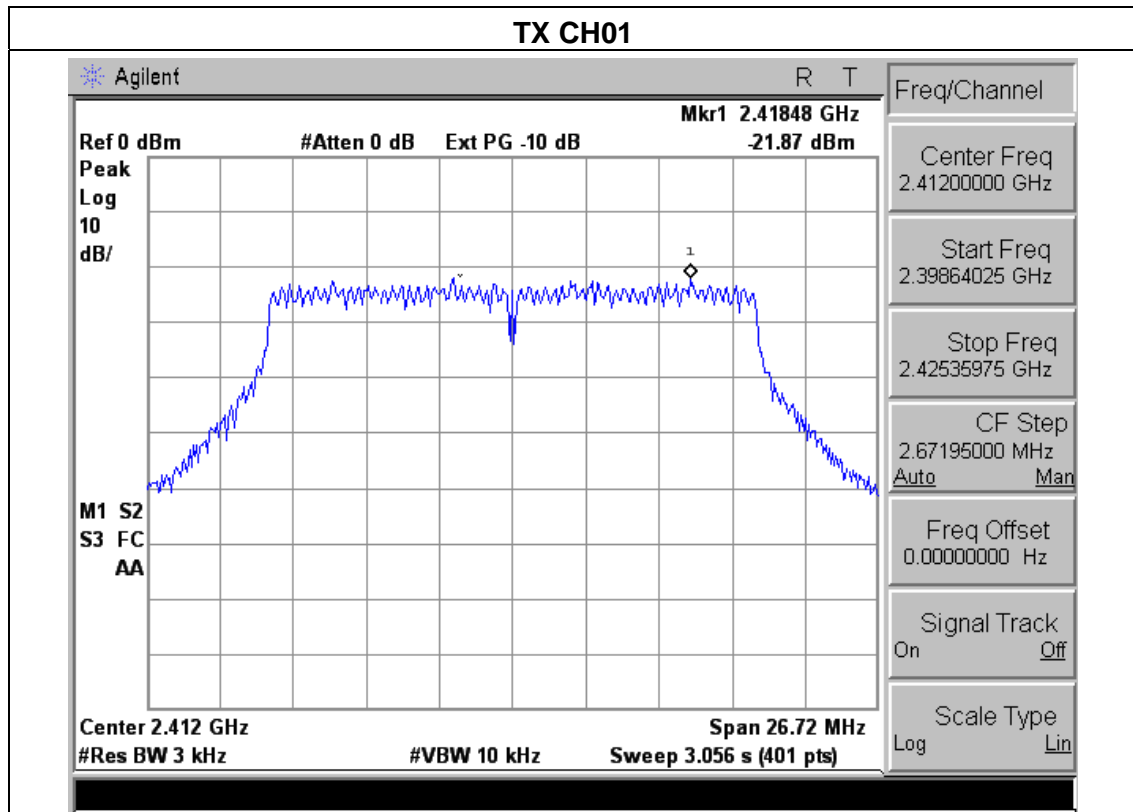

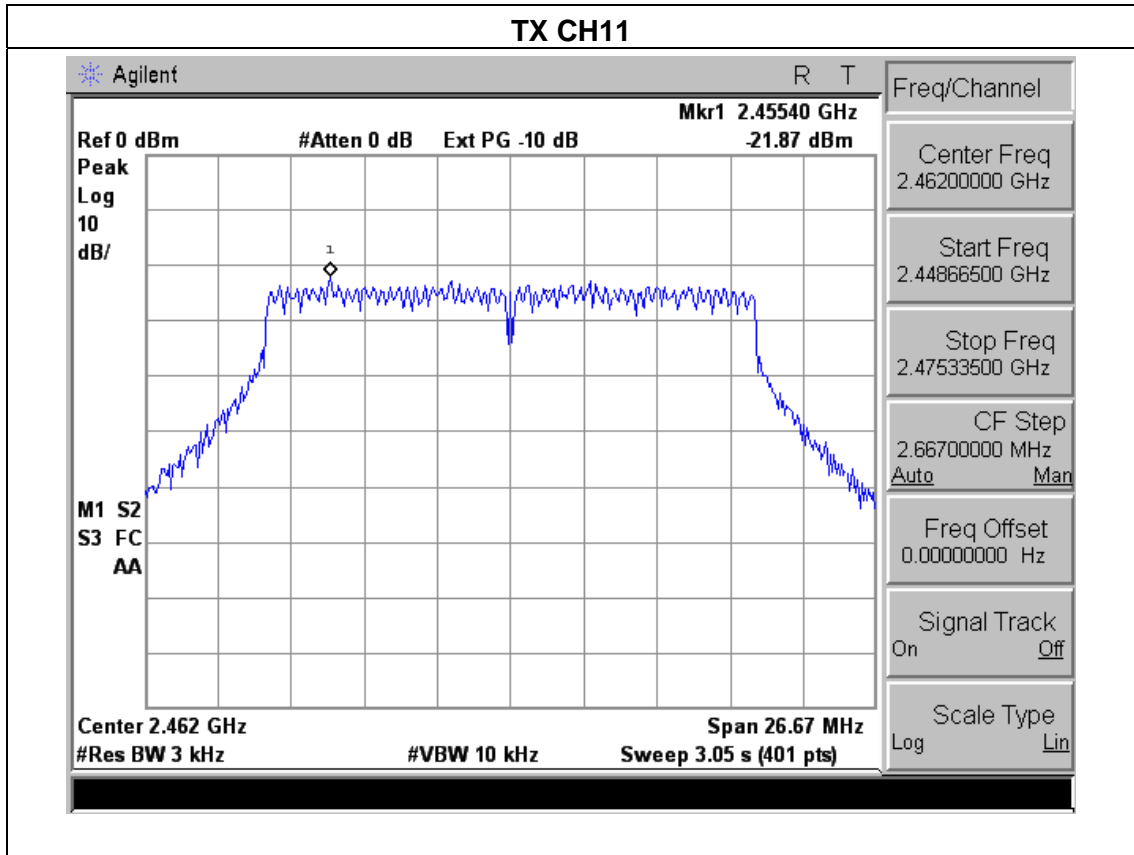
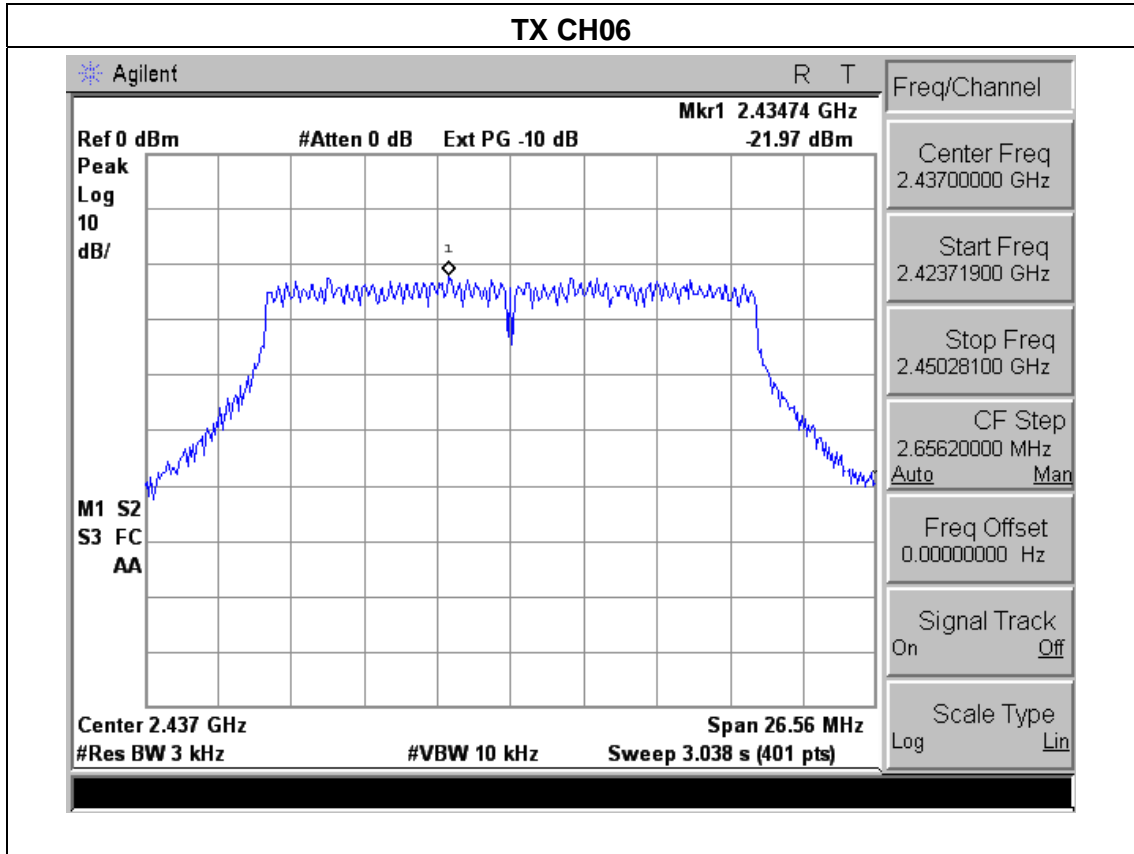

5. BANDWIDTH TEST

5.1 APPLIED PROCEDURES / LIMIT

FCC Part15 (15.247) , Subpart C				
Section	Test Item	Limit	Frequency Range (MHz)	Result
15.247(a)(2)	Bandwidth	$\geq 500\text{KHz}$ (6dB bandwidth)	2400-2483.5	PASS

5.1.1 TEST PROCEDURE

1. Set resolution bandwidth (RBW) = 1-5% or DTS BW, not to exceed 100 kHz.
2. Set the video bandwidth (VBW) $\geq 3 \times$ RBW.
3. Detector = Peak.
4. Trace mode = max hold.
5. Sweep = auto couple.
6. Allow the trace to stabilize.
7. Measure the maximum width of the emission that is constrained by the frequencies associated with the two outermost amplitude points (upper and lower) that are attenuated by 6 dB relative to the maximum level measured in the fundamental emission.

5.1.2 DEVIATION FROM STANDARD

No deviation.

5.1.3 TEST SETUP



5.1.4 EUT OPERATION CONDITIONS

The EUT tested system was configured as the statements of 2.4 Unless otherwise a special operating condition is specified in the follows during the testing.

5.1.5 TEST RESULTS

EUT :	WIFI Module	Model Name :	ESP-12
Temperature :	25 °C	Relative Humidity :	60%
Pressure :	1012 hPa	Test Voltage :	AC 120V
Test Mode :	TX b Mode /CH01, CH06, CH11		

Channel	Frequency (MHz)	6dB bandwidth (MHz)	Limit (kHz)	Result
Low	2412	10.10	500	Pass
Middle	2437	10.09	500	Pass
High	2462	10.09	500	Pass

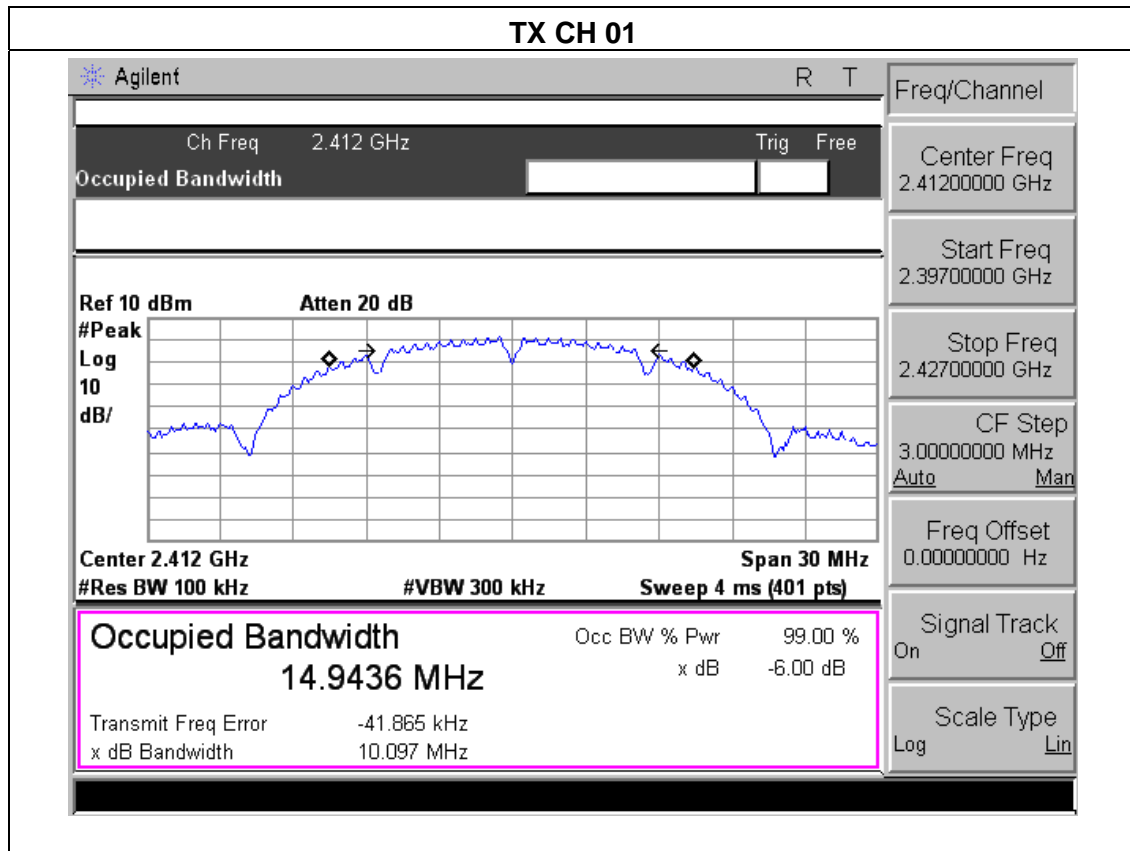

TX CH 06

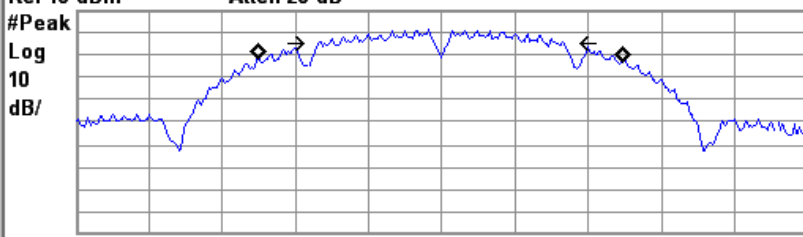
Agilent		R	T	Freq/Channel	
Ch Freq 2.437 GHz		Trig Free		Center Freq 2.43700000 GHz	
Occupied Bandwidth				Start Freq 2.42200000 GHz	
Ref 10 dBm		Atten 20 dB		Stop Freq 2.45200000 GHz	
				CF Step 3.00000000 MHz Auto Man	
Center 2.437 GHz		Span 30 MHz		Freq Offset 0.00000000 Hz	
#Res BW 100 kHz		#VBW 300 kHz		Sweep 4 ms (401 pts)	
Occupied Bandwidth 14.9681 MHz		Occ BW % Pwr 99.00 %		Signal Track On Off	
x dB Bandwidth 10.085 MHz		x dB -6.00 dB		Scale Type Log Lin	
Transmit Freq Error -38.554 kHz					

TX CH 11

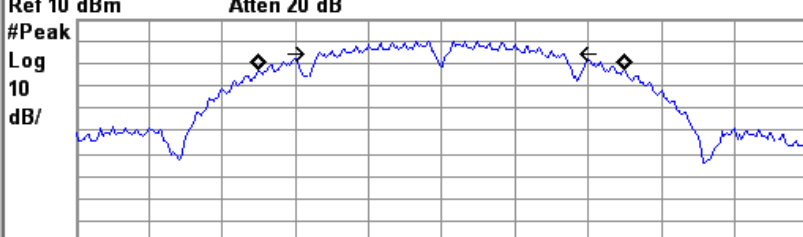
Agilent		R	T	Freq/Channel	
Ch Freq 2.462 GHz		Trig Free		Center Freq 2.46200000 GHz	
Occupied Bandwidth				Start Freq 2.44700000 GHz	
Ref 10 dBm		Atten 20 dB		Stop Freq 2.47700000 GHz	
				CF Step 3.00000000 MHz Auto Man	
Center 2.462 GHz		Span 30 MHz		Freq Offset 0.00000000 Hz	
#Res BW 100 kHz		#VBW 300 kHz		Sweep 4 ms (401 pts)	
Occupied Bandwidth 14.9964 MHz		Occ BW % Pwr 99.00 %		Signal Track On Off	
x dB Bandwidth 10.093 MHz		x dB -6.00 dB		Scale Type Log Lin	
Transmit Freq Error -10.239 kHz					

EUT :	WIFI Module	Model Name :	ESP-12
Temperature :	25 °C	Relative Humidity :	60%
Pressure :	1012 hPa	Test Voltage :	AC 120V
Test Mode :	TX g Mode /CH01, CH06, CH11		

Channel	Frequency (MHz)	6dB bandwidth (MHz)	Limit (kHz)	Result
Low	2412	16.51	500	Pass
Middle	2437	16.56	500	Pass
High	2462	16.51	500	Pass

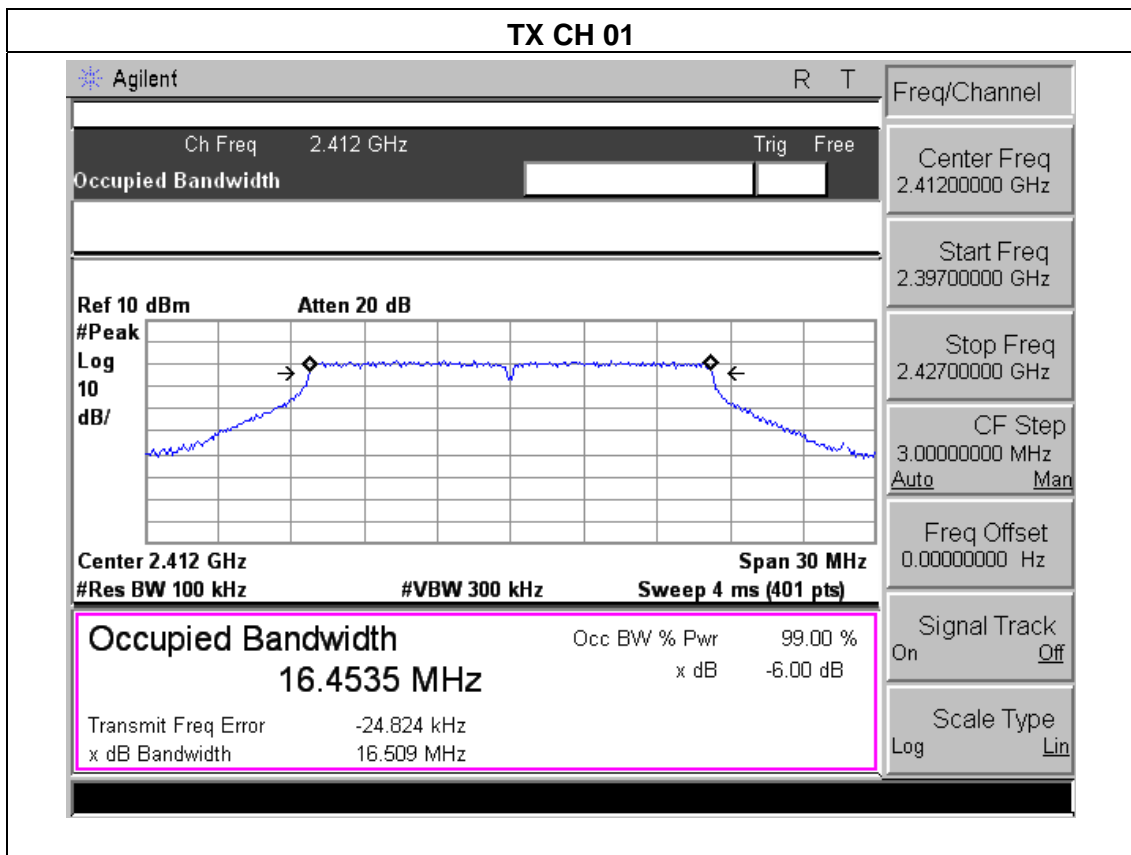

TX CH 06

Agilent		R	T	Freq/Channel	
Ch Freq 2.437 GHz		Trig Free		Center Freq 2.43700000 GHz	
Occupied Bandwidth				Start Freq 2.42200000 GHz	
Ref 10 dBm		Atten 20 dB		Stop Freq 2.45200000 GHz	
				CF Step 3.00000000 MHz Auto Man	
Center 2.437 GHz		Span 30 MHz		Freq Offset 0.00000000 Hz	
#Res BW 100 kHz		#VBW 300 kHz		Sweep 4 ms (401 pts)	
Occupied Bandwidth 16.4637 MHz		Occ BW % Pwr 99.00 %		Signal Track On Off	
x dB Bandwidth 16.561 MHz		x dB -6.00 dB		Scale Type Log Lin	
Transmit Freq Error -24.960 kHz					

TX CH 11

Agilent		R	T	Freq/Channel	
Ch Freq 2.462 GHz		Trig Free		Center Freq 2.46200000 GHz	
Occupied Bandwidth				Start Freq 2.44700000 GHz	
Ref 10 dBm		Atten 20 dB		Stop Freq 2.47700000 GHz	
				CF Step 3.00000000 MHz Auto Man	
Center 2.462 GHz		Span 30 MHz		Freq Offset 0.00000000 Hz	
#Res BW 100 kHz		#VBW 300 kHz		Sweep 4 ms (401 pts)	
Occupied Bandwidth 16.4547 MHz		Occ BW % Pwr 99.00 %		Signal Track On Off	
x dB Bandwidth 16.513 MHz		x dB -6.00 dB		Scale Type Log Lin	
Transmit Freq Error -26.834 kHz					



EUT :	WIFI Module	Model Name :	ESP-12
Temperature :	25 °C	Relative Humidity :	60%
Pressure :	1012 hPa	Test Voltage :	AC 120V
Test Mode :	TX n Mode /CH01, CH06, CH11		

Channel	Frequency (MHz)	6dB bandwidth (MHz)	Limit (kHz)	Result
Low	2412	17.81	500	Pass
Middle	2437	17.71	500	Pass
High	2462	17.78	500	Pass

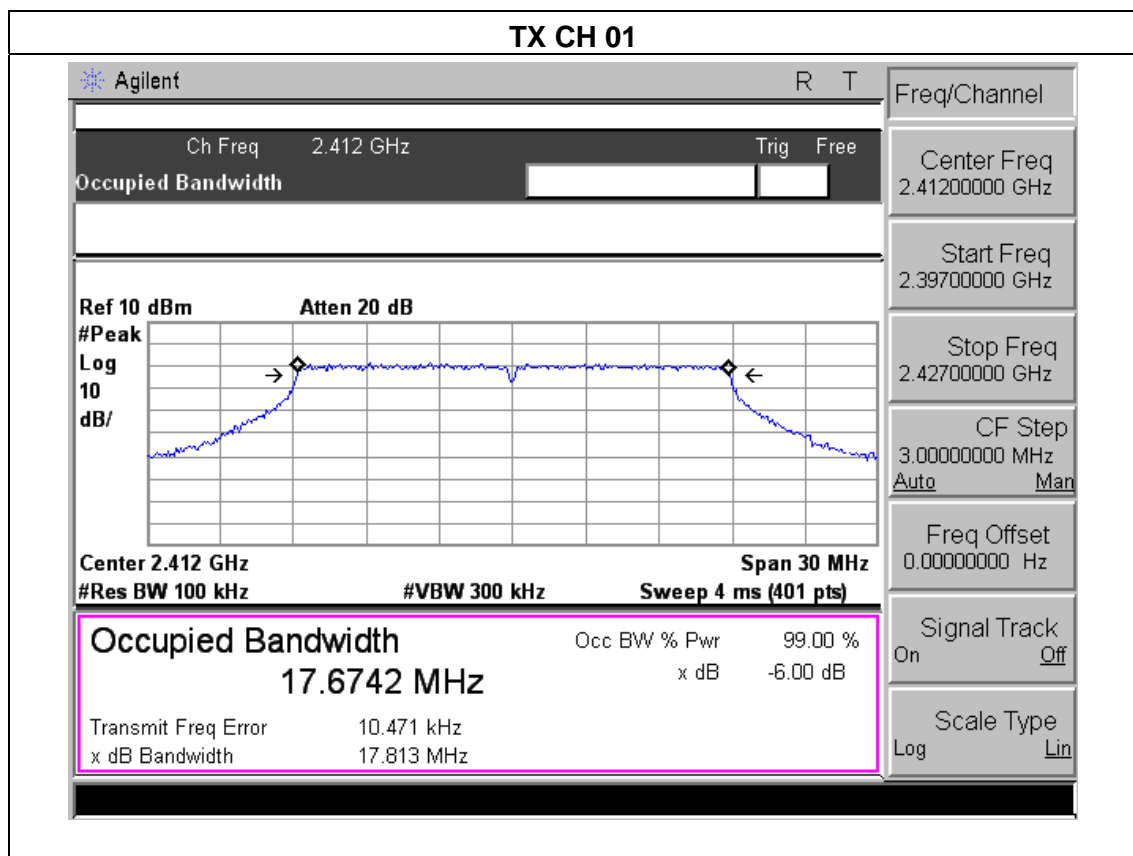



TX CH 06

Agilent		R	T	Freq/Channel	
Ch Freq 2.437 GHz		Trig Free		Center Freq 2.43700000 GHz	
Occupied Bandwidth				Start Freq 2.42200000 GHz	
Ref 10 dBm		Atten 20 dB		Stop Freq 2.45200000 GHz	
				CF Step 3.00000000 MHz Auto Man	
Center 2.437 GHz		Span 30 MHz		Freq Offset 0.00000000 Hz	
#Res BW 100 kHz		#VBW 300 kHz		Sweep 4 ms (401 pts)	
Occupied Bandwidth		Occ BW % Pwr		99.00 %	
17.6691 MHz		x dB		-6.00 dB	
Transmit Freq Error -9.794 kHz				Signal Track On Off	
x dB Bandwidth 17.708 MHz				Scale Type Log Lin	

TX CH 11

Agilent		R	T	Freq/Channel	
Ch Freq 2.462 GHz		Trig Free		Center Freq 2.46200000 GHz	
Occupied Bandwidth				Start Freq 2.44700000 GHz	
Ref 10 dBm		Atten 20 dB		Stop Freq 2.47700000 GHz	
				CF Step 3.00000000 MHz Auto Man	
Center 2.462 GHz		Span 30 MHz		Freq Offset 0.00000000 Hz	
#Res BW 100 kHz		#VBW 300 kHz		Sweep 4 ms (401 pts)	
Occupied Bandwidth		Occ BW % Pwr		99.00 %	
17.6642 MHz		x dB		-6.00 dB	
Transmit Freq Error -19.327 kHz				Signal Track On Off	
x dB Bandwidth 17.780 MHz				Scale Type Log Lin	

6. PEAK OUTPUT POWER TEST

6.1 APPLIED PROCEDURES / LIMIT

FCC Part15 (15.247) , Subpart C				
Section	Test Item	Limit	Frequency Range (MHz)	Result
15.247(b)(3)	Peak Output Power	1 watt or 30dBm	2400-2483.5	PASS

6.1.1 TEST PROCEDURE

- a. The EUT was directly connected to the Power meter

6.1.2 DEVIATION FROM STANDARD

No deviation.

6.1.3 TEST SETUP



6.1.4 EUT OPERATION CONDITIONS

The EUT tested system was configured as the statements of 2.4 Unless otherwise a special operating condition is specified in the follows during the testing.

**6.1.5 TEST RESULTS**

EUT :	WIFI Module	Model Name :	ESP-12
Temperature :	25 °C	Relative Humidity :	60%
Pressure :	1012 hPa	Test Voltage :	AC 120V
Test Mode :	TX b/g/n Mode /CH01, CH06, CH11		

TX 802.11b Mode			
Test Channe	Frequency	Maximum Conducted Output Power(PK)	LIMIT
	(MHz)	(dBm)	dBm
CH01	2412	15.61	30
CH06	2437	15.59	30
CH11	2462	15.42	30
TX 802.11g Mode			
CH01	2412	13.79	30
CH06	2437	13.65	30
CH11	2462	13.70	30
TX 802.11n Mode			
CH01	2412	12.78	30
CH06	2437	12.72	30
CH11	2462	12.64	30

7. 100 KHZ BANDWIDTH OF FREQUENCY BAND EDGE

APPLICABLE STANDARD

In any 100 kHz bandwidth outside the frequency band in which the spread spectrum or digitally modulated intentional radiator is operating, the radio frequency power that is produced by the intentional radiator shall be at least 20 dB below that in the 100 kHz bandwidth within the band that contains the highest level of the desired power, based on either an RF conducted or a radiated measurement, provided the transmitter demonstrates compliance with the peak conducted power limits. If the transmitter complies with the conducted power limits based on the use of RMS averaging over a time interval, as permitted under paragraph (b)(3) of this section, the attenuation required under this paragraph shall be 30 dB instead of 20 dB. Attenuation below the general limits specified in §15.209(a) is not required. In addition, radiated emissions which fall in the restricted bands, as defined in §15.205(a), must also comply with the radiated emission limits specified in §15.209(a) (see §15.205(c)).

TEST PROCEDURE

- a) Check the calibration of the measuring instrument using either an internal calibrator or a known signal from an external generator.
- b) Position the EUT without connection to measurement instrument. Turn on the EUT and connect its antenna terminal to measurement instrument via a low loss cable. Then set it to any one measured frequency within its operating range, and make sure the instrument is operated in its linear range.
- c) Set RBW to 100 kHz and VBW of spectrum analyzer to 300 kHz with a convenient frequency span including 100 kHz bandwidth from band edge.
- d) Measure the highest amplitude appearing on spectral display and set it as a reference level. Plot the graph with marking the highest point and edge frequency.
- e) Repeat above procedures until all measured frequencies were complete.

7.1 DEVIATION FROM STANDARD

No deviation.

7.2 TEST SETUP



7.3 EUT OPERATION CONDITIONS

The EUT tested system was configured as the statements of 2.4 Unless otherwise a special operating condition is specified in the follows during the testing.

7.4 TEST RESULTS

EUT :	WIFI Module	Model Name :	ESP-12
Temperature :	25 °C	Relative Humidity :	60%
Pressure :	1012 hPa	Test Voltage :	AC 120V

Frequency Band	Delta Peak to band emission (dBc)	> Limit (dBc)	Result
802.11b mode			
Left-band	38.27	20	Pass
Right-band	55.71	20	Pass
802.11g mode			
Left-band	32.19	20	Pass
Right-band	46.93	20	Pass
802.11n mode			
Left-band	31.05	20	Pass
Right-band	45.11	20	Pass

Frequency (MHz)	Meter Reading (dBμV)	Factor (dB)	Emission Level (dBμV/m)	Limits (dBμV/m)	Margin (dB)	Detector Type	Comment
802.11b							
2390	58.36	-13.06	45.30	74	-28.70	peak	Vertical
2390	59.20	-13.06	46.14	74	-27.86	peak	Horizontal
2483.5	59.20	-12.78	46.42	74	-27.58	peak	Vertical
2483.5	52.74	-12.78	39.96	74	-34.04	peak	Horizontal
802.11g							
2390	58.41	-13.06	45.35	74	-28.65	peak	Vertical
2390	55.29	-13.06	42.23	74	-31.77	peak	Horizontal
2483.5	60.51	-12.78	47.73	74	-26.27	peak	Vertical
2483.5	61.19	-12.78	48.41	74	-25.59	peak	Horizontal
802.11n							
2390	61.94	-13.06	48.88	74	-25.12	peak	Vertical
2390	61.97	-13.06	48.91	74	-25.09	peak	Horizontal
2483.5	58.21	-12.78	45.46	74	-28.54	peak	Vertical
2483.5	55.51	-12.78	42.73	74	-31.27	peak	Horizontal

802.11b: Band Edge, Left Side

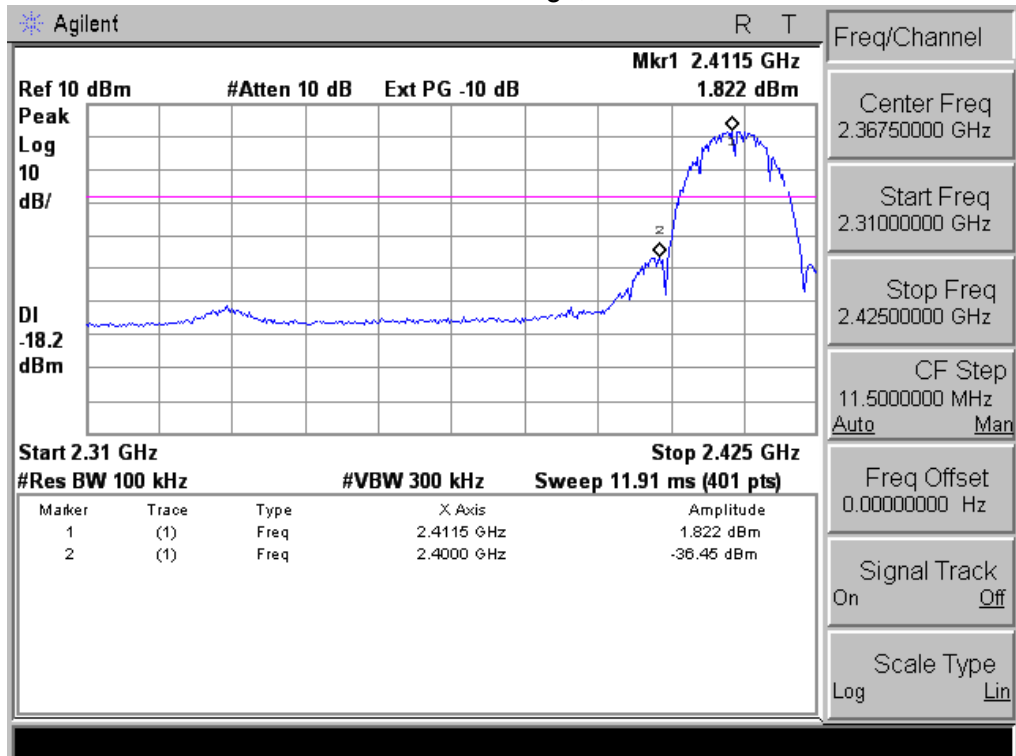

802.11b: Band Edge, Right Side

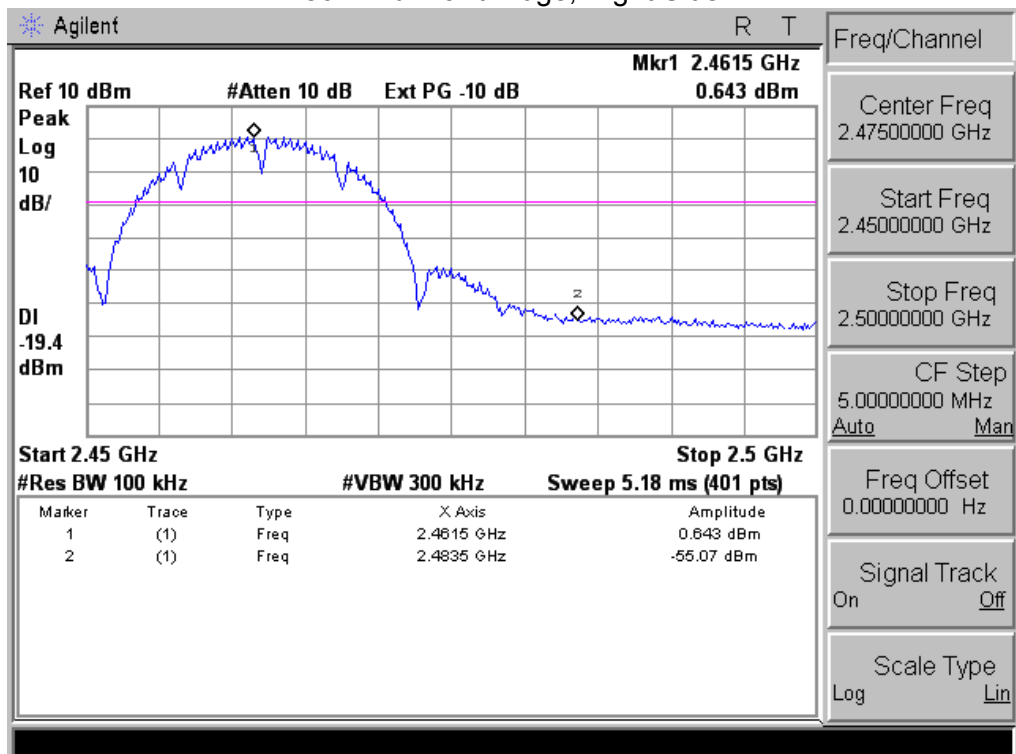



802.11g: Band Edge, Left Side

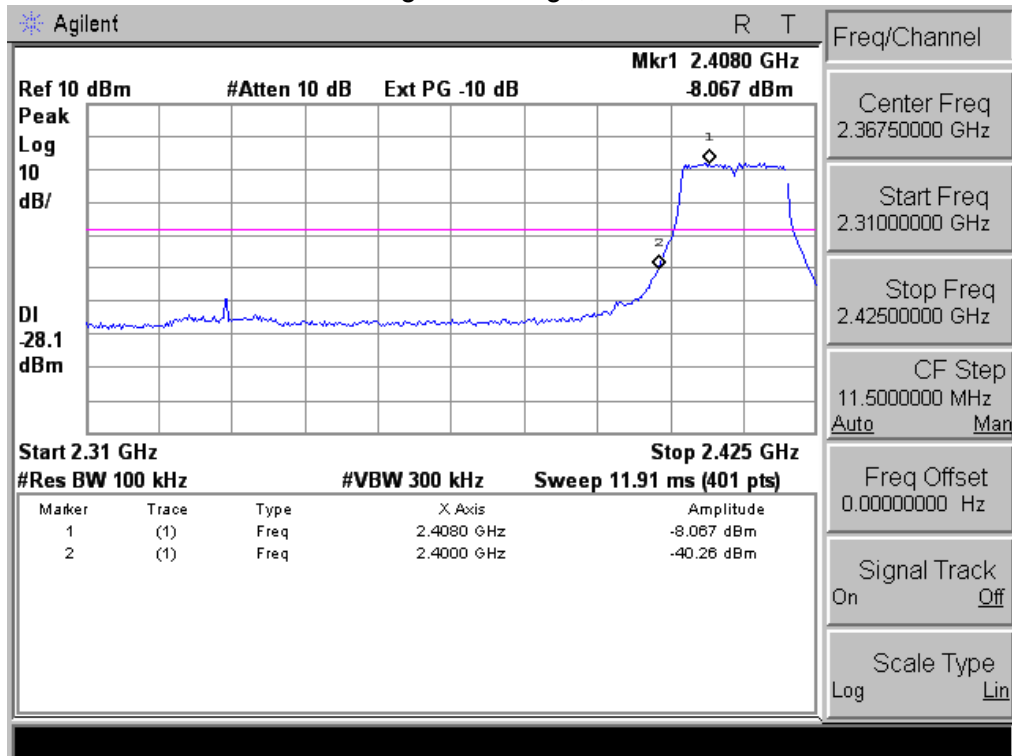

802.11g: Band Edge, Right Side

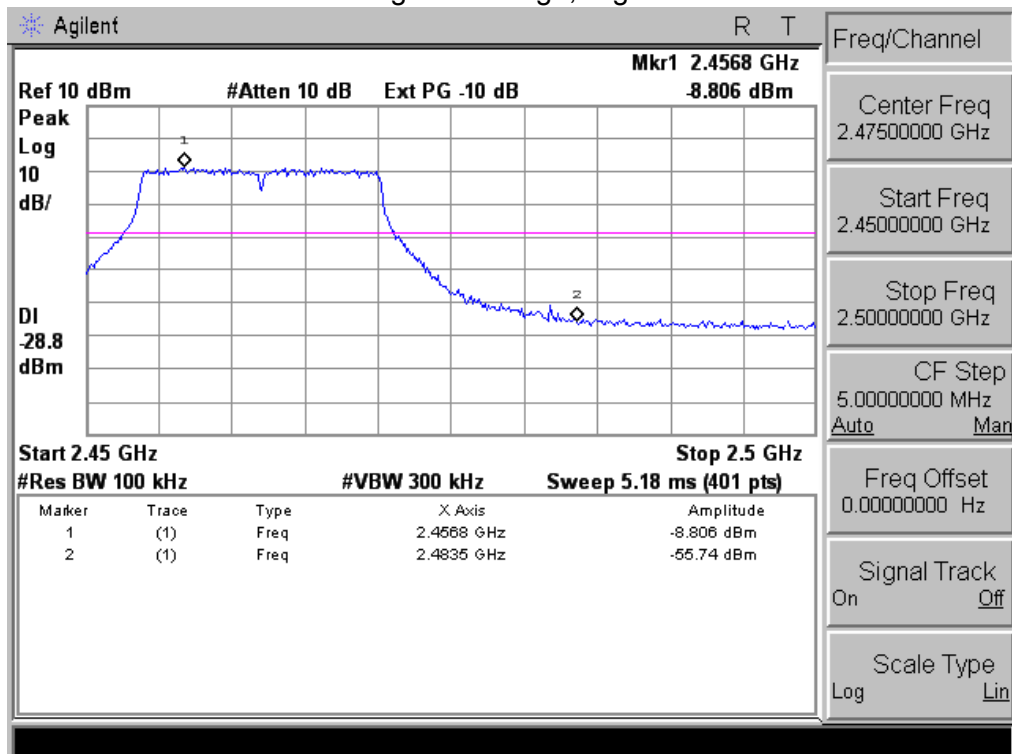



802.11n: Band Edge, Left Side

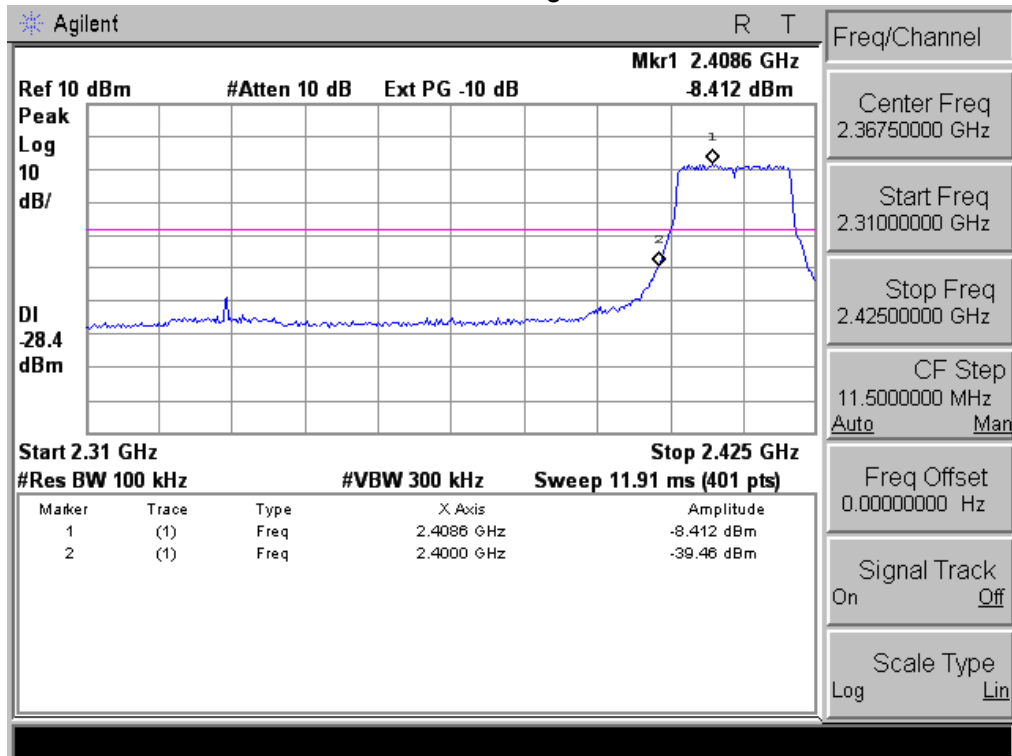

802.11n: Band Edge, Right Side

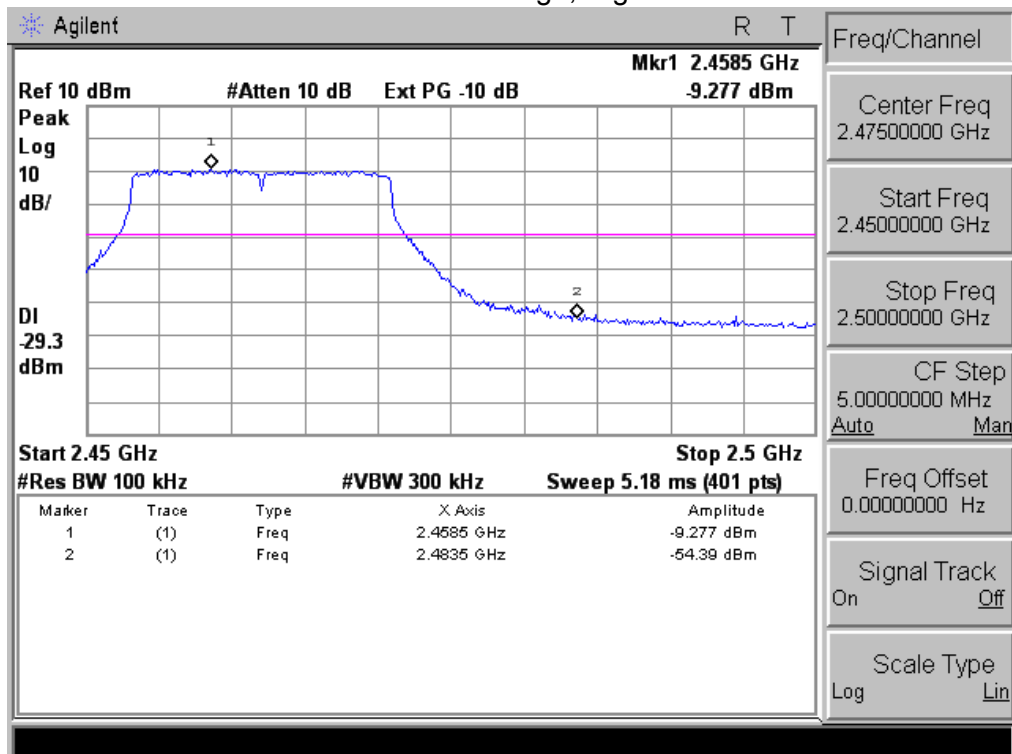



8. ANTENNA REQUIREMENT

8.1 STANDARD REQUIREMENT

15.203 requirement: For intentional device, according to 15.203: an intentional radiator shall be designed to ensure that no antenna other than that furnished by the responsible party shall be used with the device.

8.2 EUT ANTENNA

The EUT antenna is Integrated(PCB) antenna. It comply with the standard requirement.

9. EUT TEST PHOTO

Radiated Measurement Photos

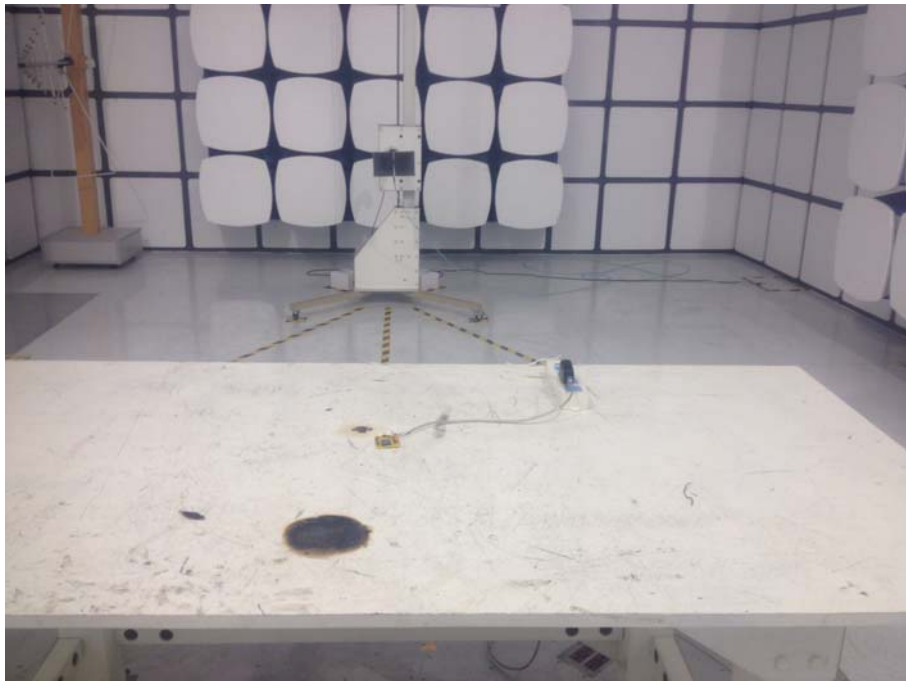
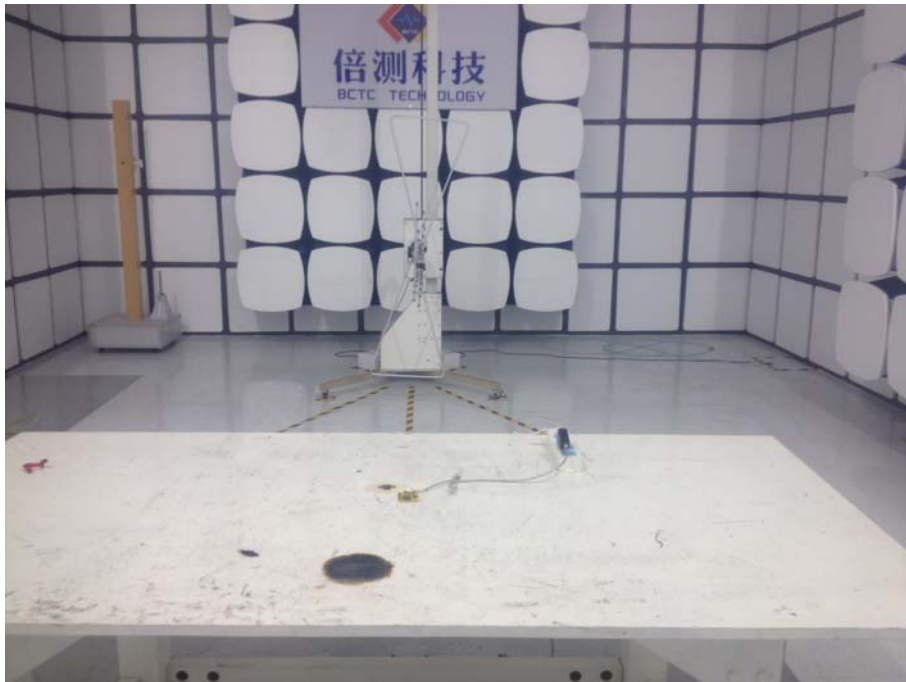

Conducted Emission

